

**B1**

3  
CLOSET DOOR WILL HAVE A 1" UNDERCUT TO ALLEVIATE TEMPERATURE DIFFERENCE WITH ADJACENT SPACES.

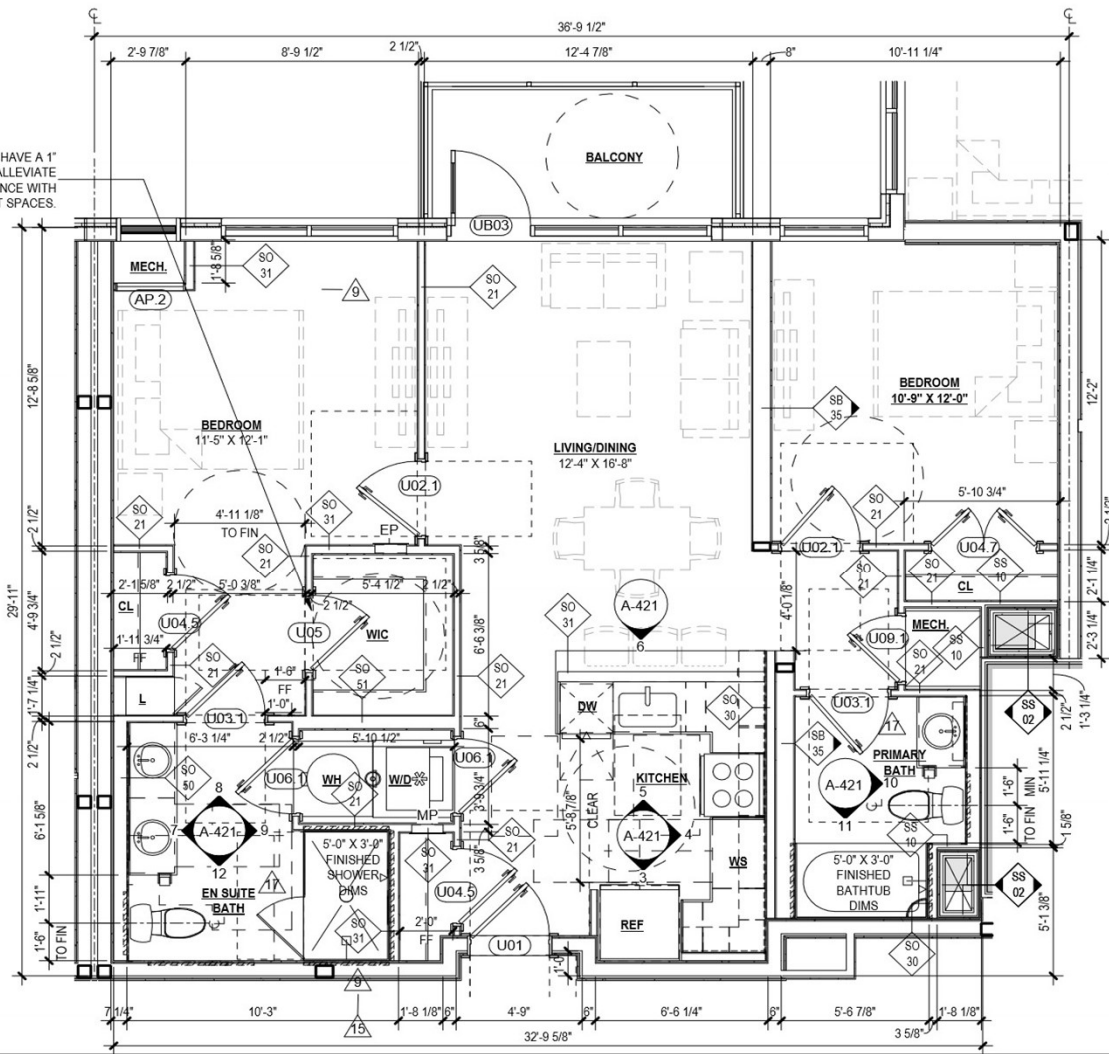

1  
A-421 **UNIT B1 PLAN**  
Scale: 1/4" = 1'-0"

TOTAL 9 UNIT	AREA	1043 GSF
--------------	------	----------

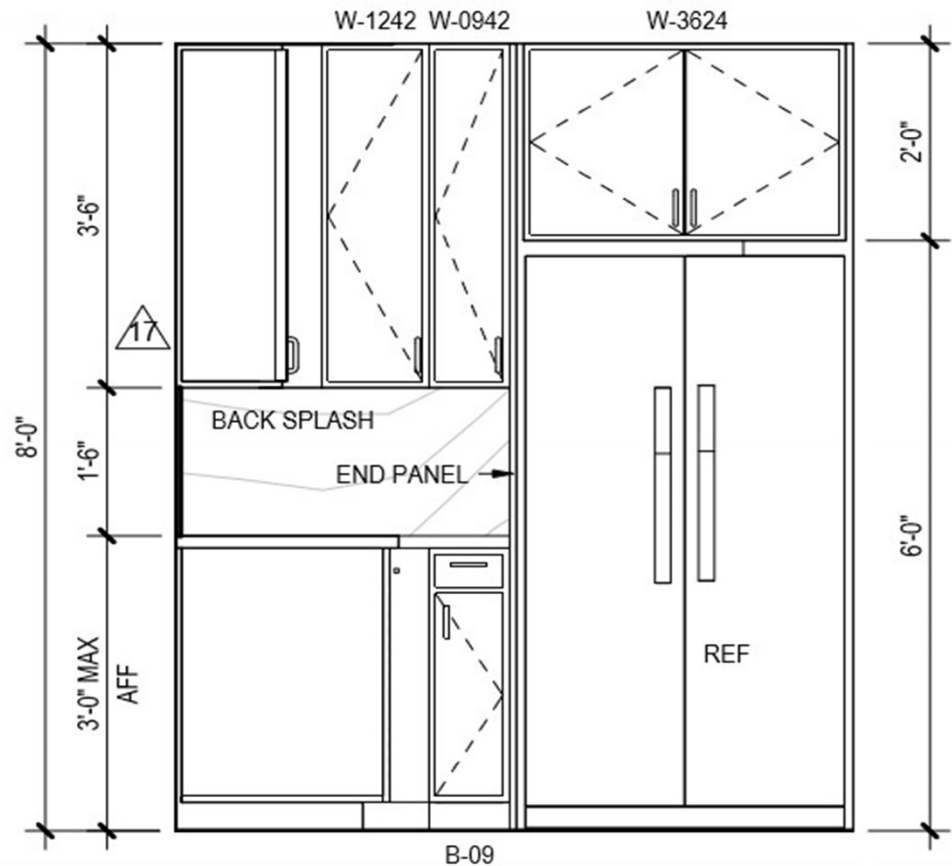

3  
A-421

# UNIT B1 - KITCHEN - ELEV 1

Scale: 1/2" = 1'-0"

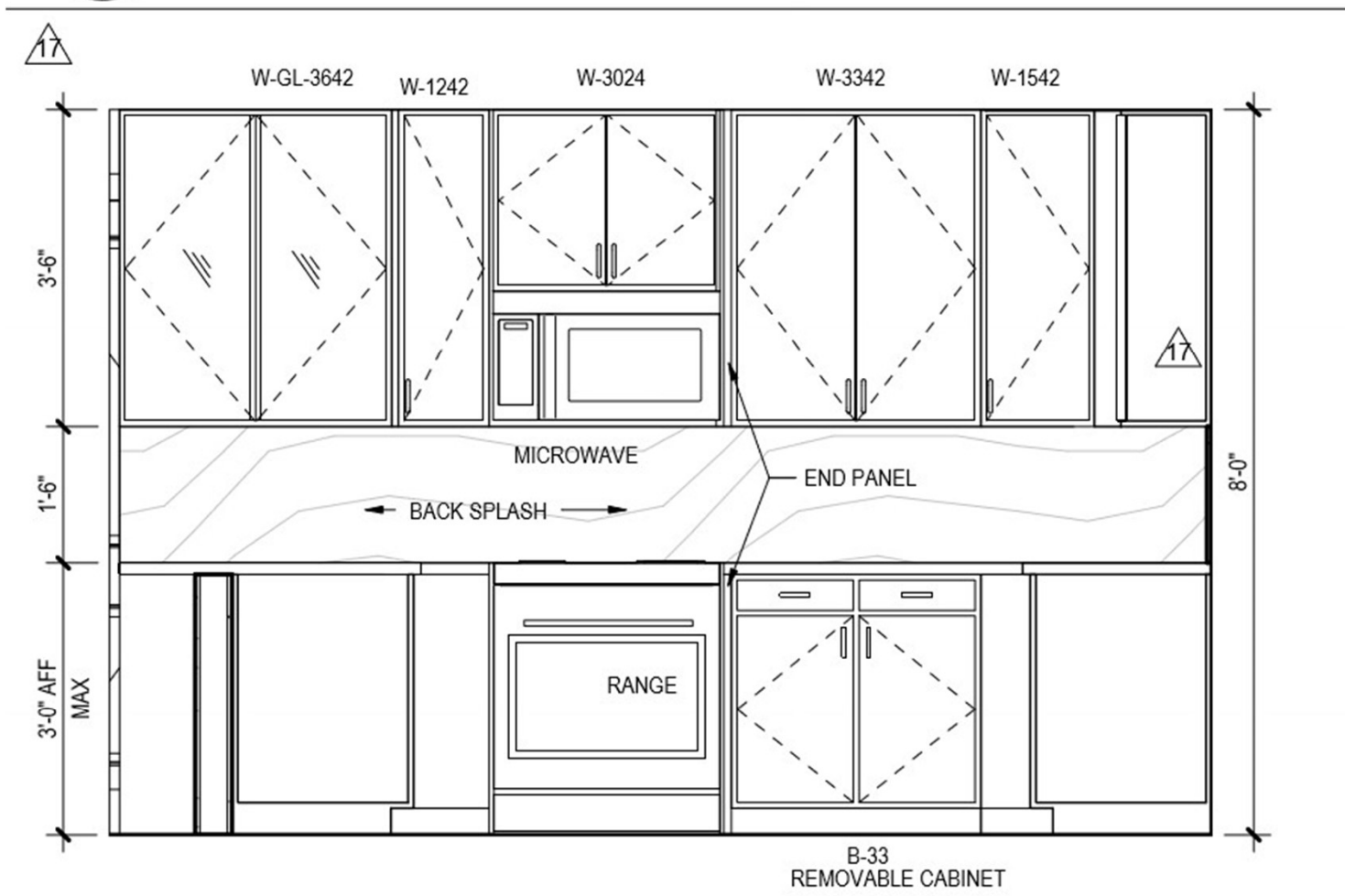

4  
A-421

# UNIT B1 - KITCHEN - ELEV 2

Scale: 1/2" = 1'-0"

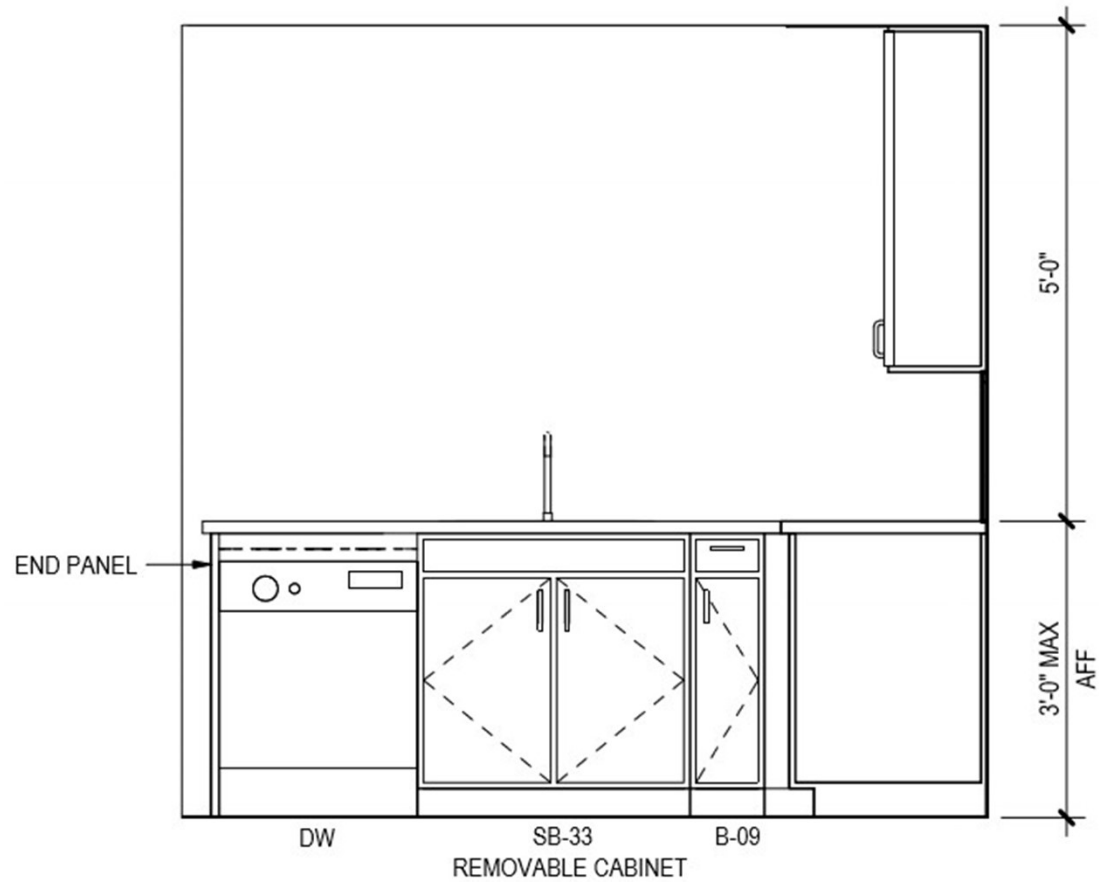

5  
A-421

# UNIT B1 - KITCHEN - ELEV 3

Scale: 1/2" = 1'-0"

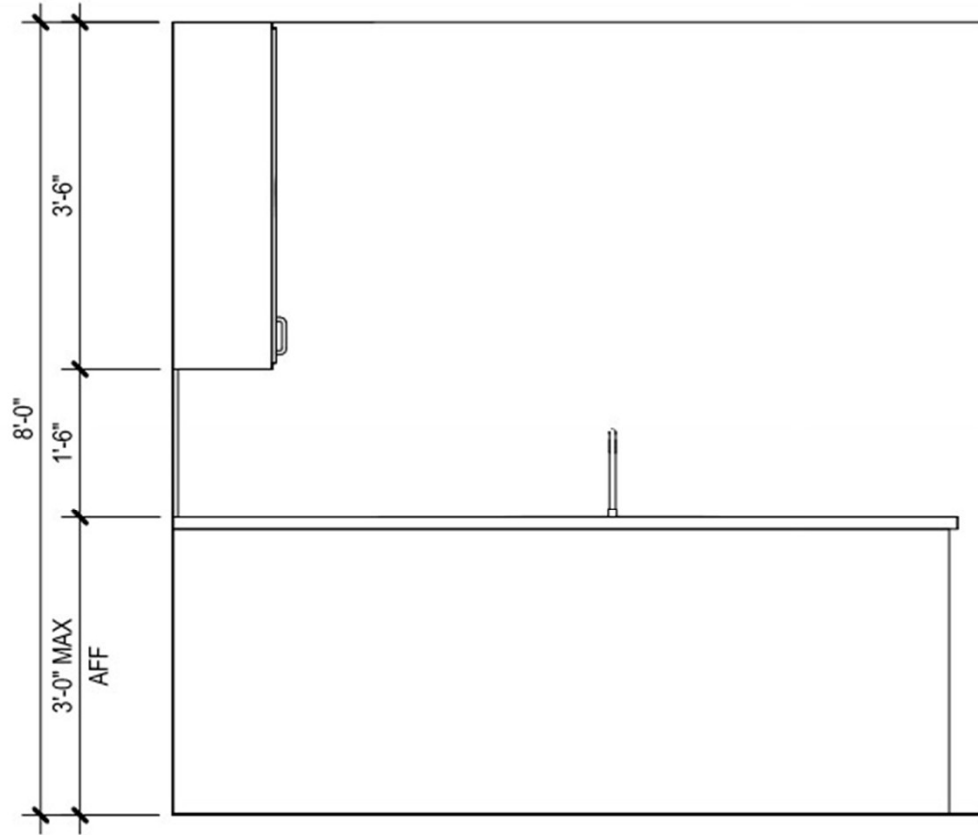

6  
A-421

## UNIT B1 - KITCHEN - ELEV 4

Scale: 1/2" = 1'-0"

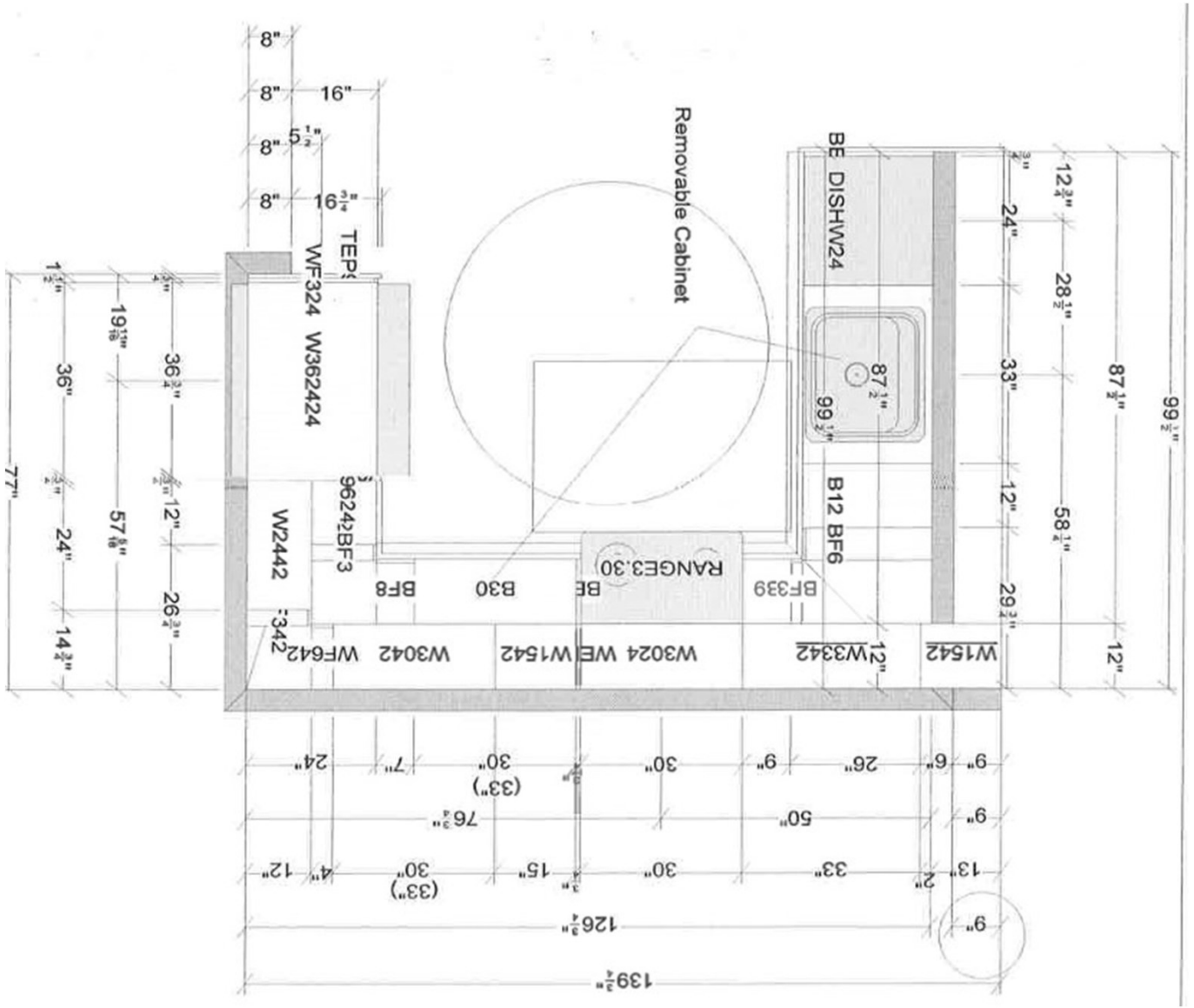

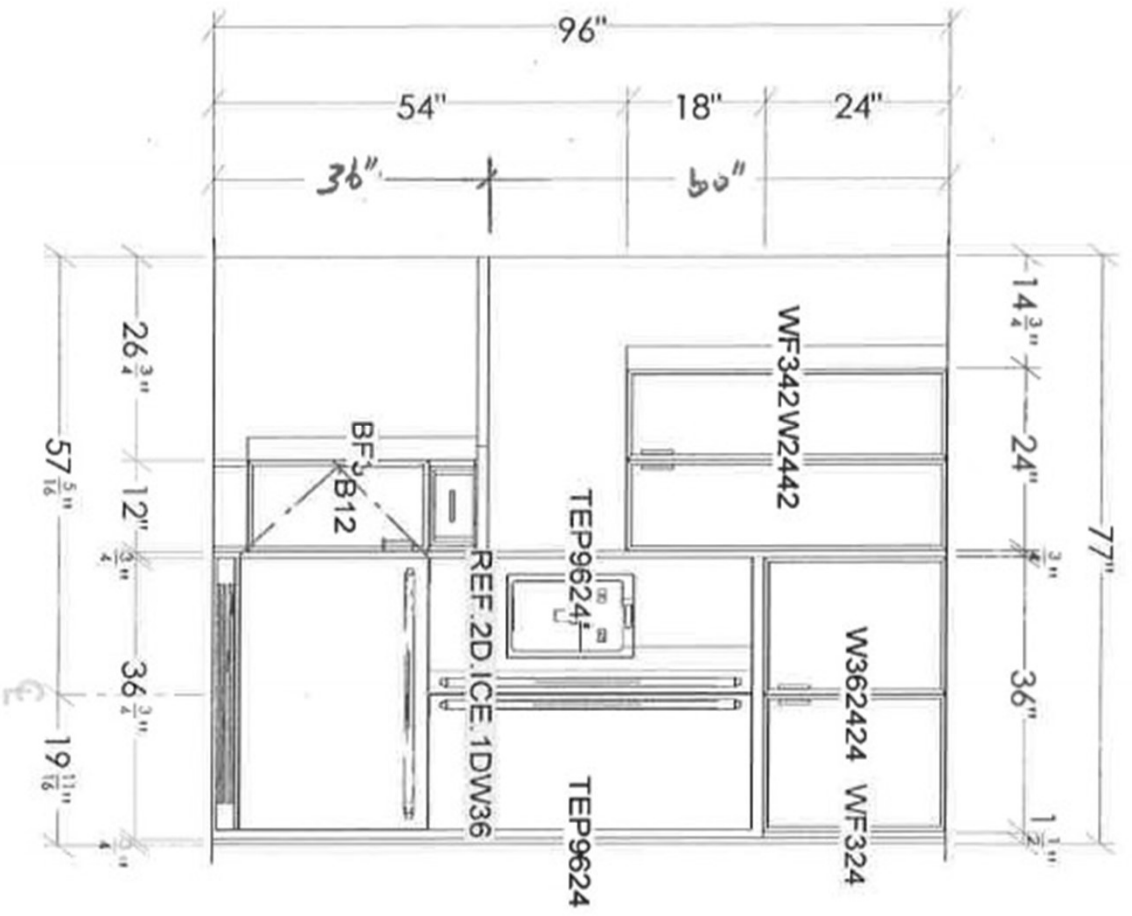



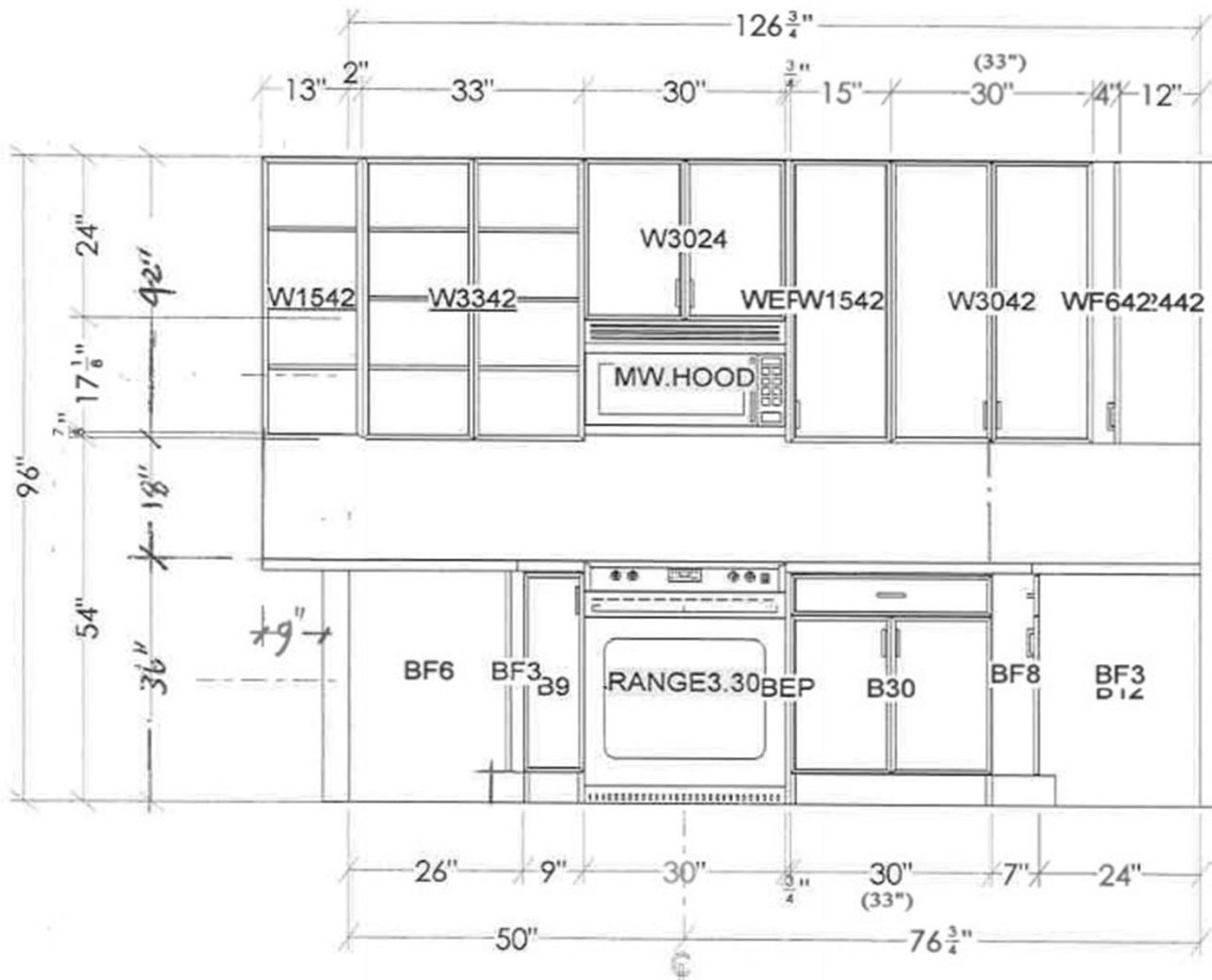

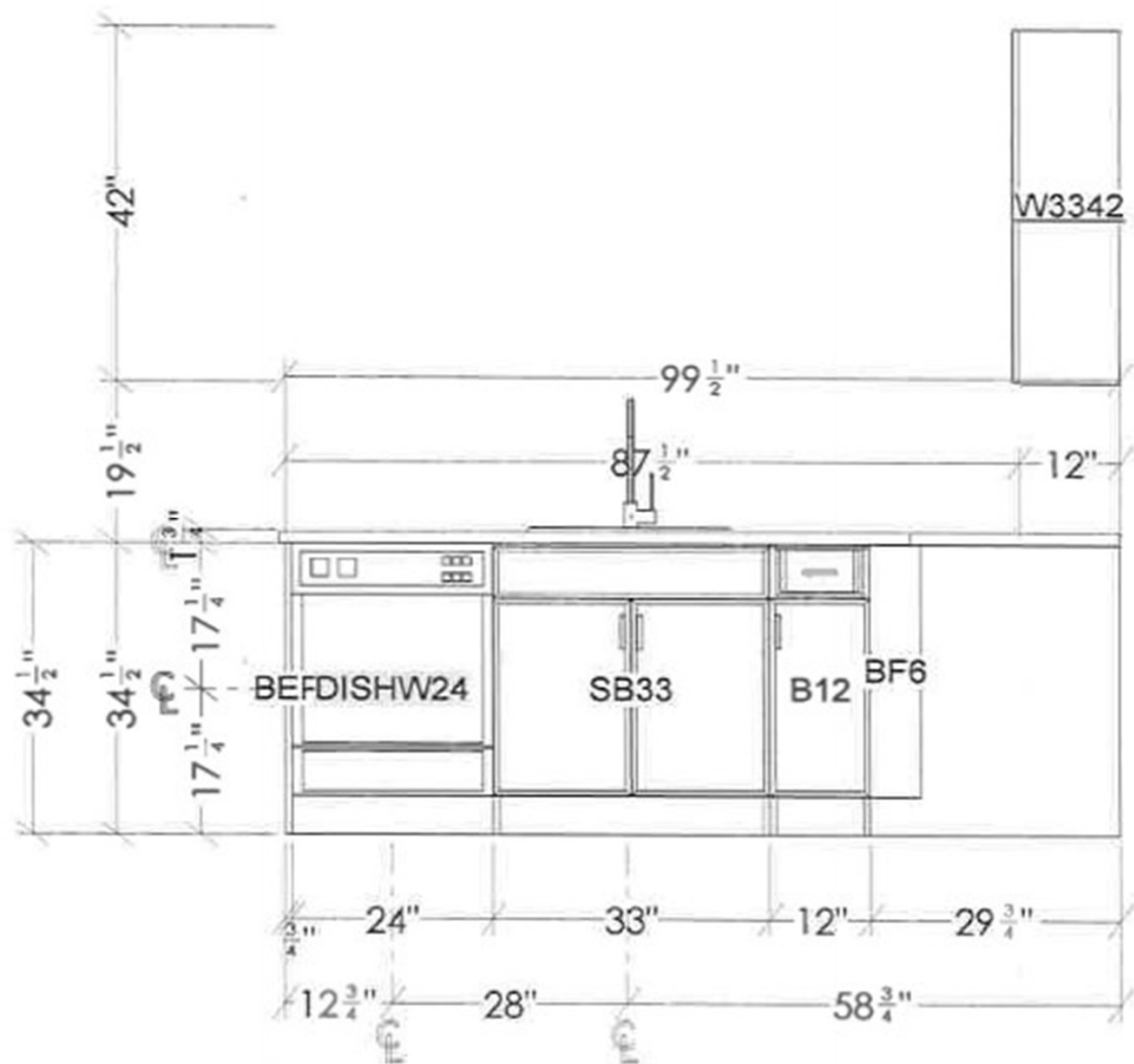



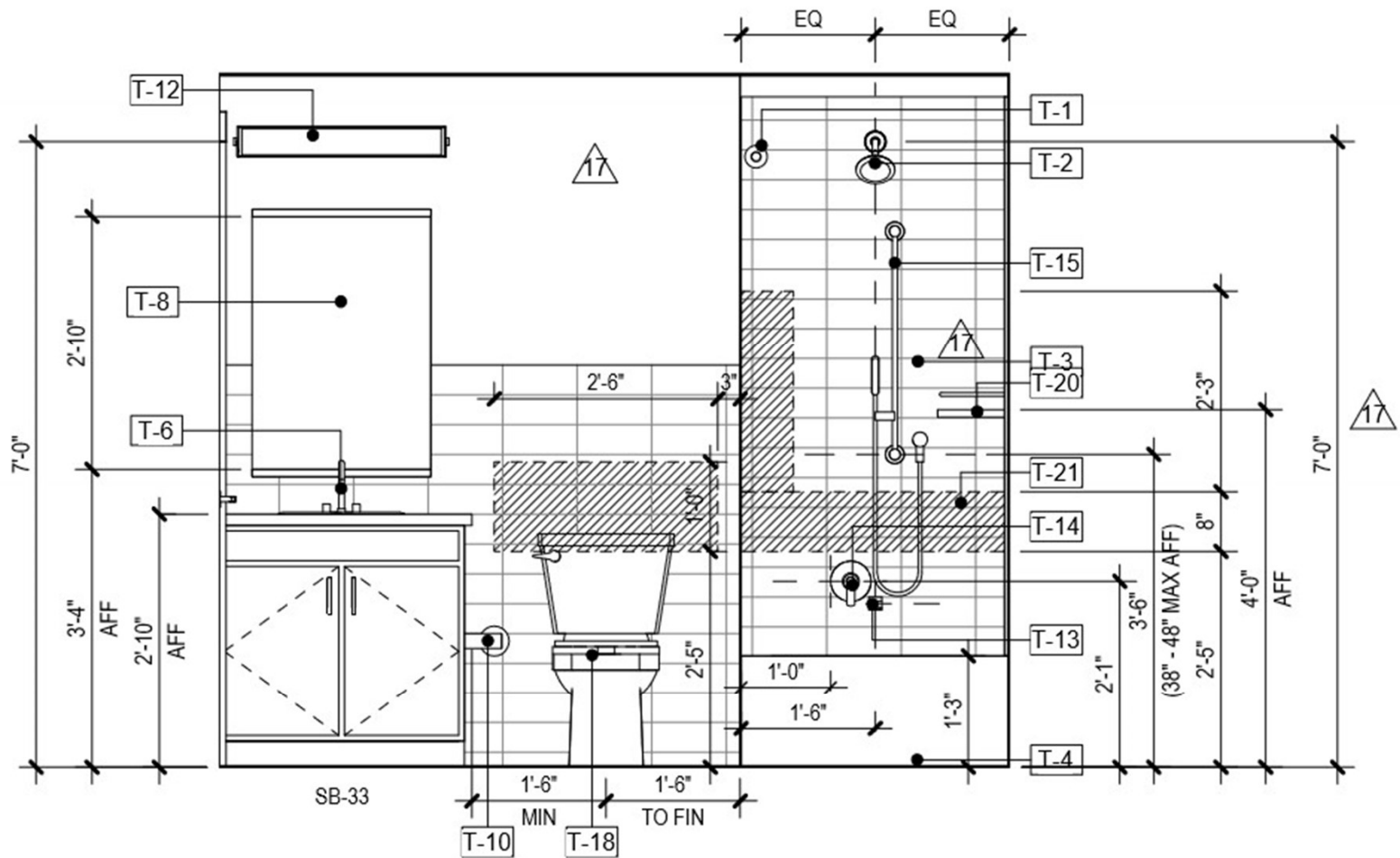

10  
A-421

# UNIT B1 - PRIMARY BATH - ELEV 1



Scale: 1/2" = 1'-0"

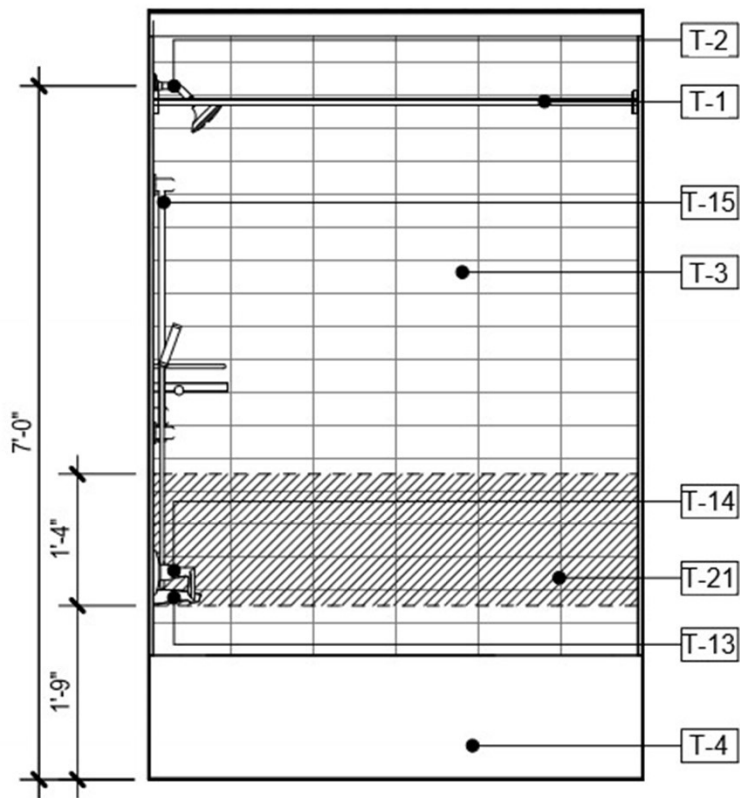

11  
A-421

# UNIT B1 - PRIMARY BATH - ELEV 2

Scale: 1/2" = 1'-0"

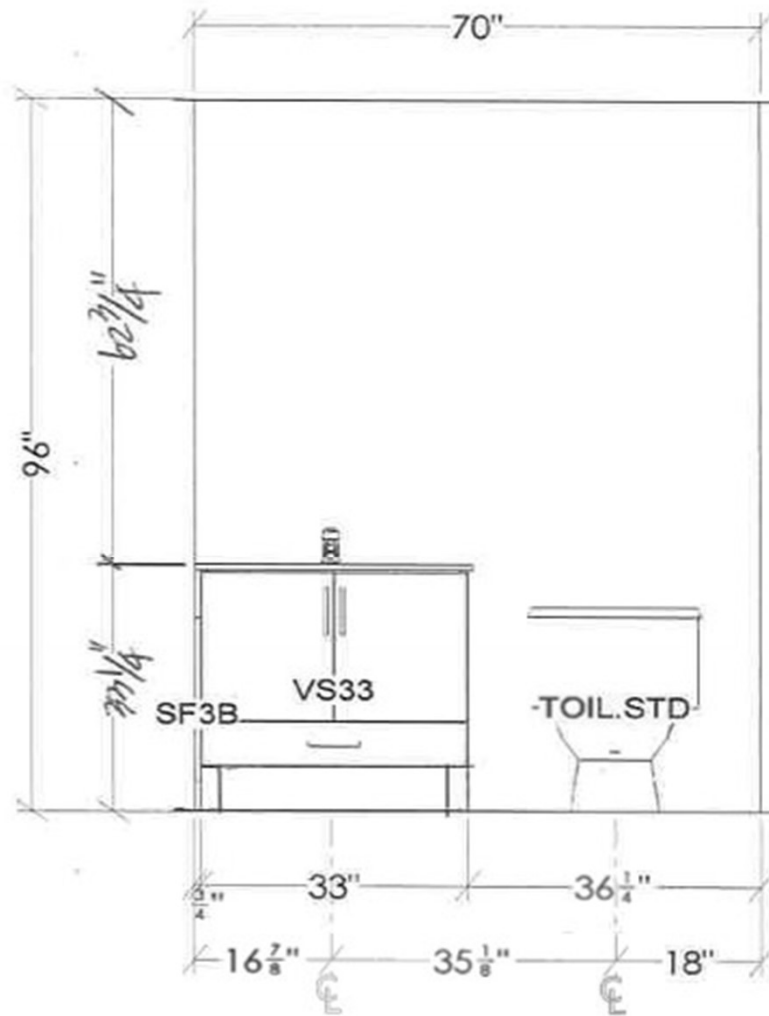

# PRIMARY BATH

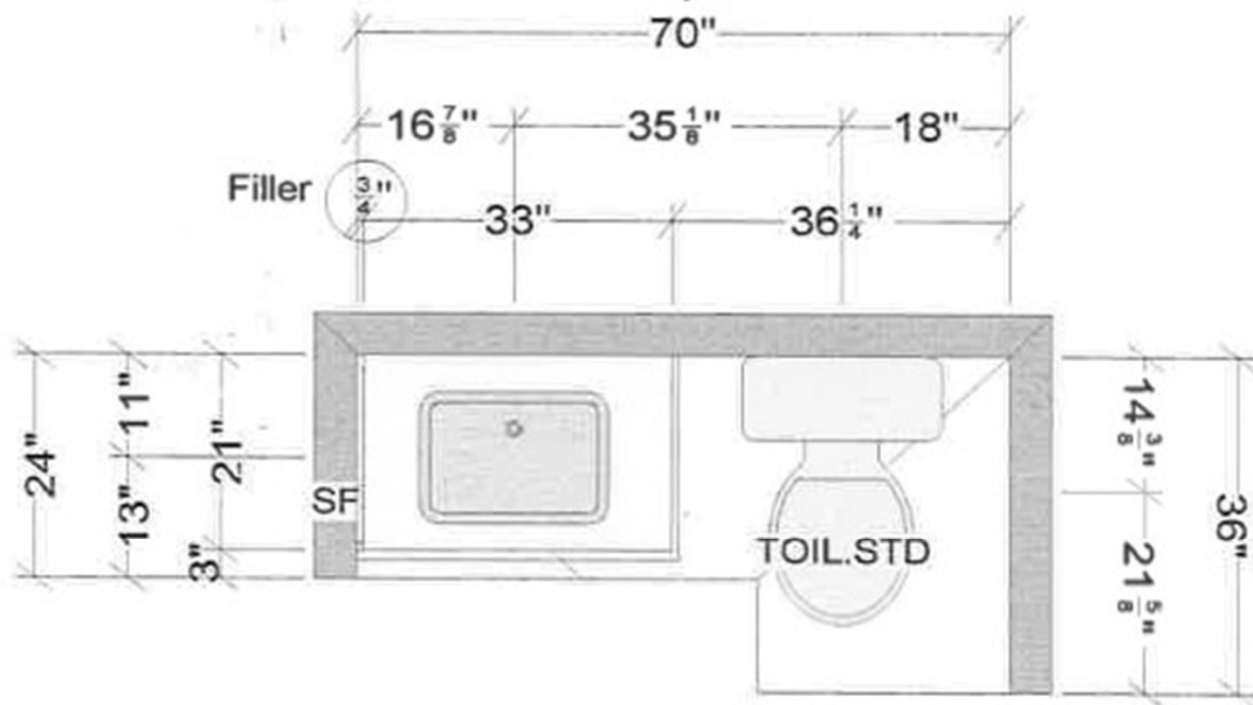

**Unit B1 Primary Bath**

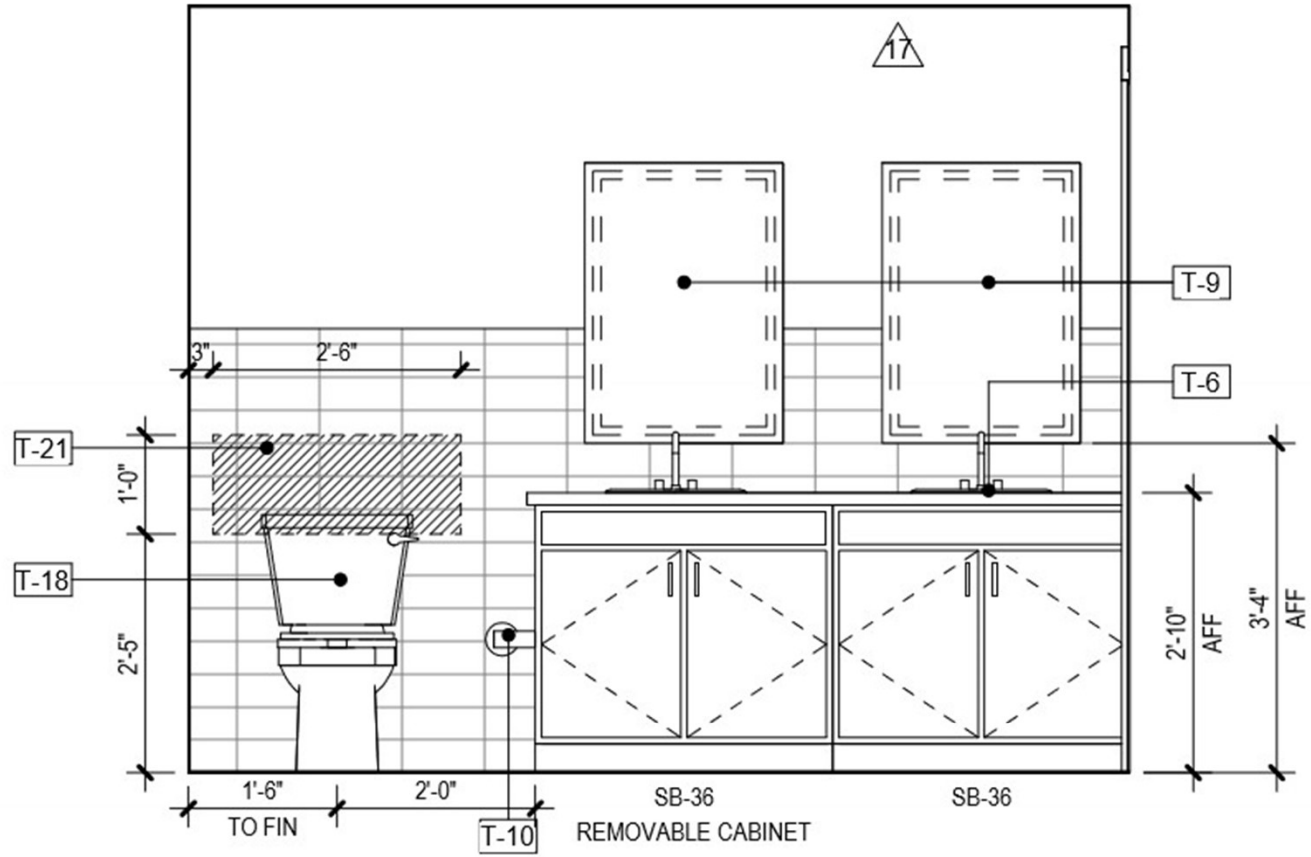

7  
A-421

# UNIT B1 - EN SUITE BATH - ELEV 1

Scale: 1/2" = 1'-0"





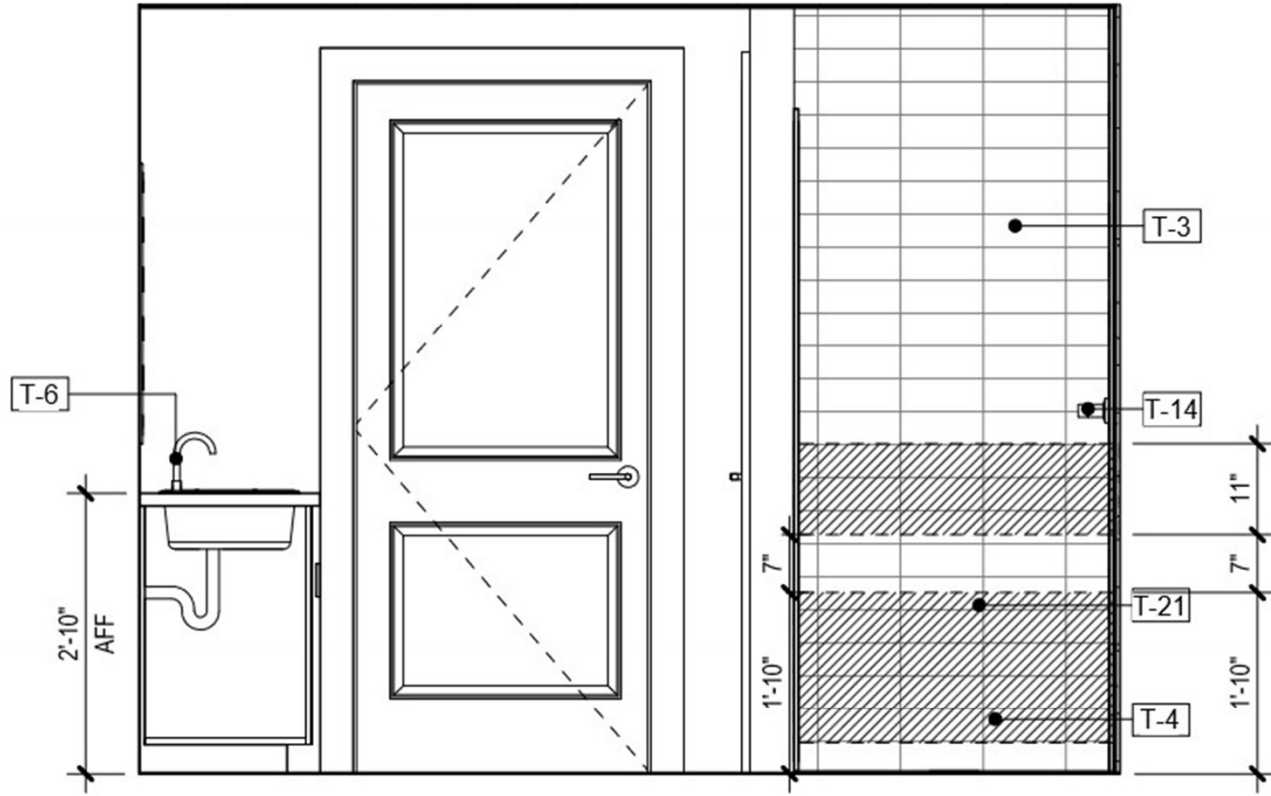

8  
A-421

UNIT B1 - EN SUITE BATH - ELEV 2

Scale: 1/2" = 1'-0"

17

RFI 4

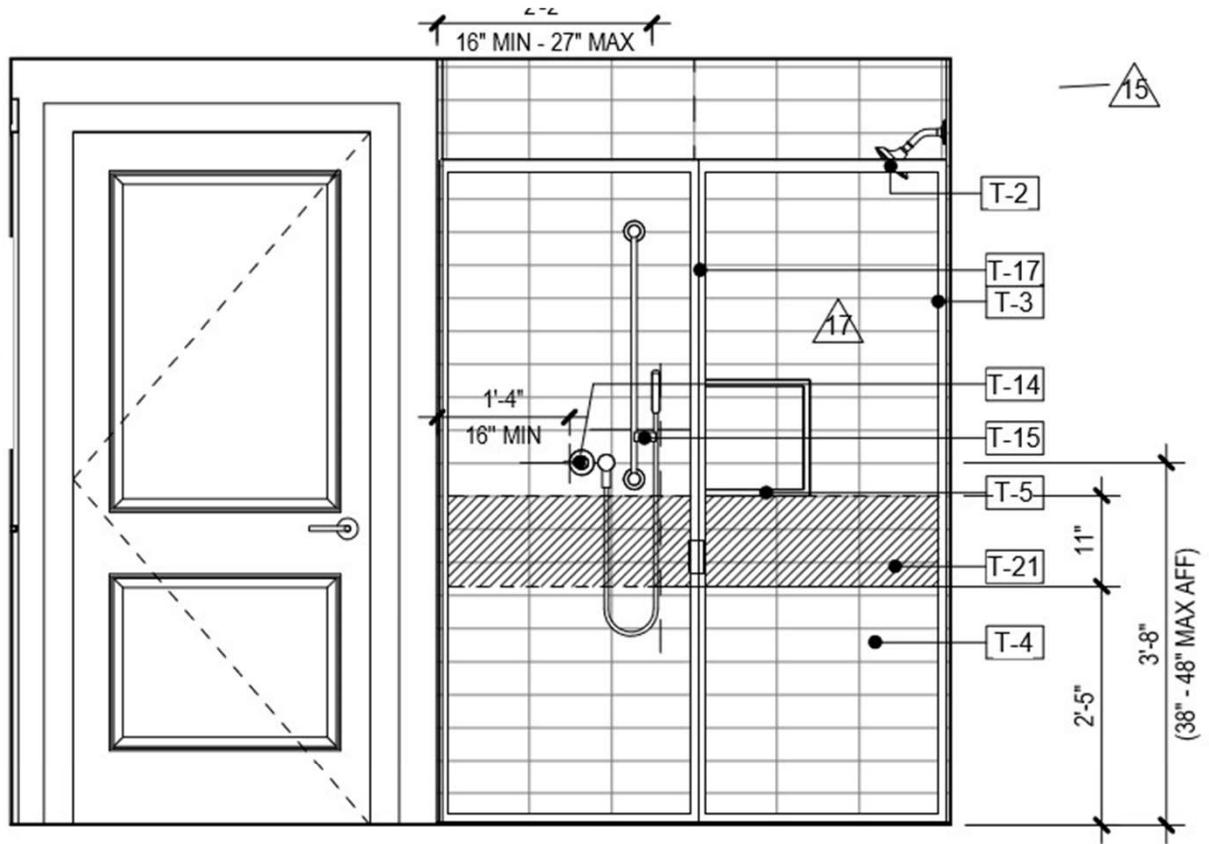

9  
A-421

# UNIT B1 - EN SUITE BATH - ELEV 3

Scale: 1/2" = 1'-0"



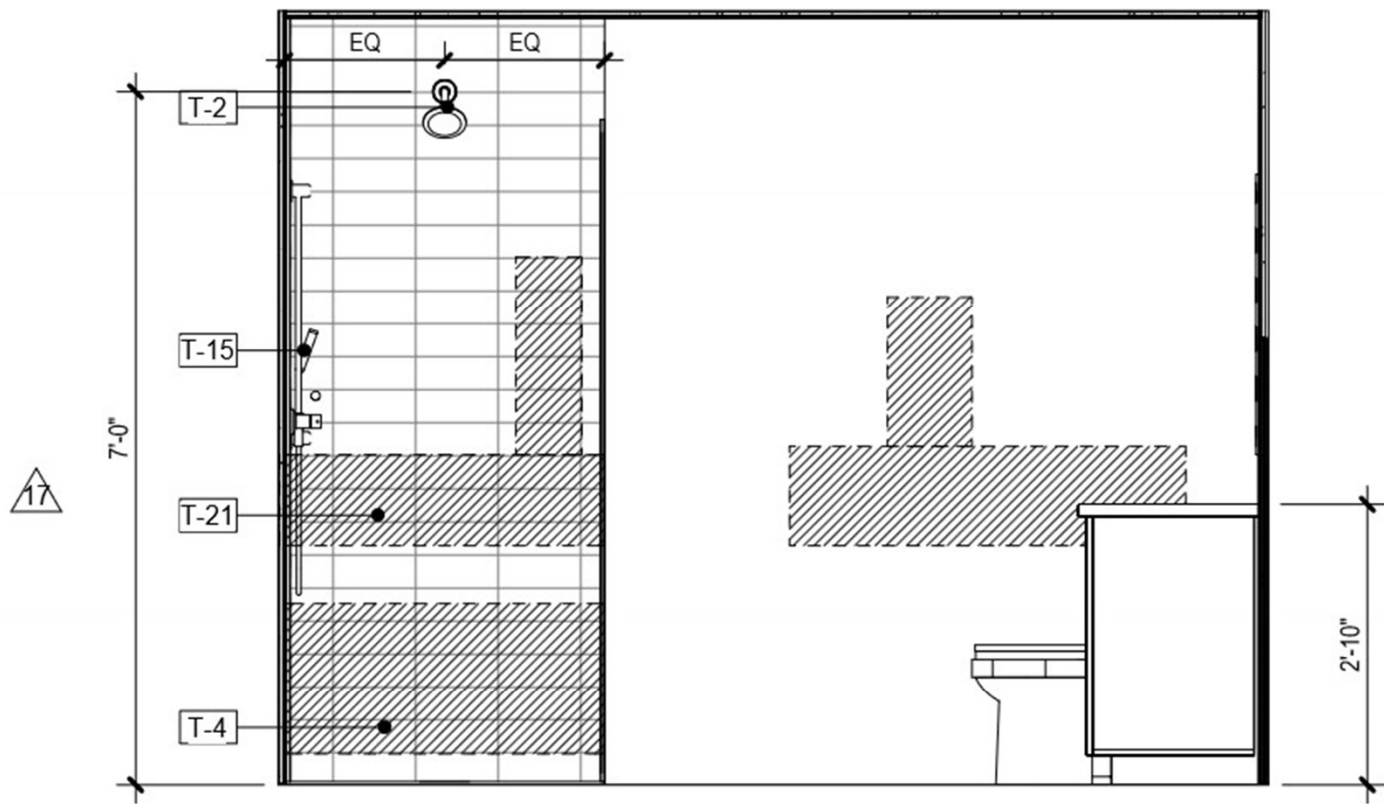

12  
A-421

## UNIT B1 - EN SUITE BATH - ELEV 4

Scale: 1/2" = 1'-0"

17

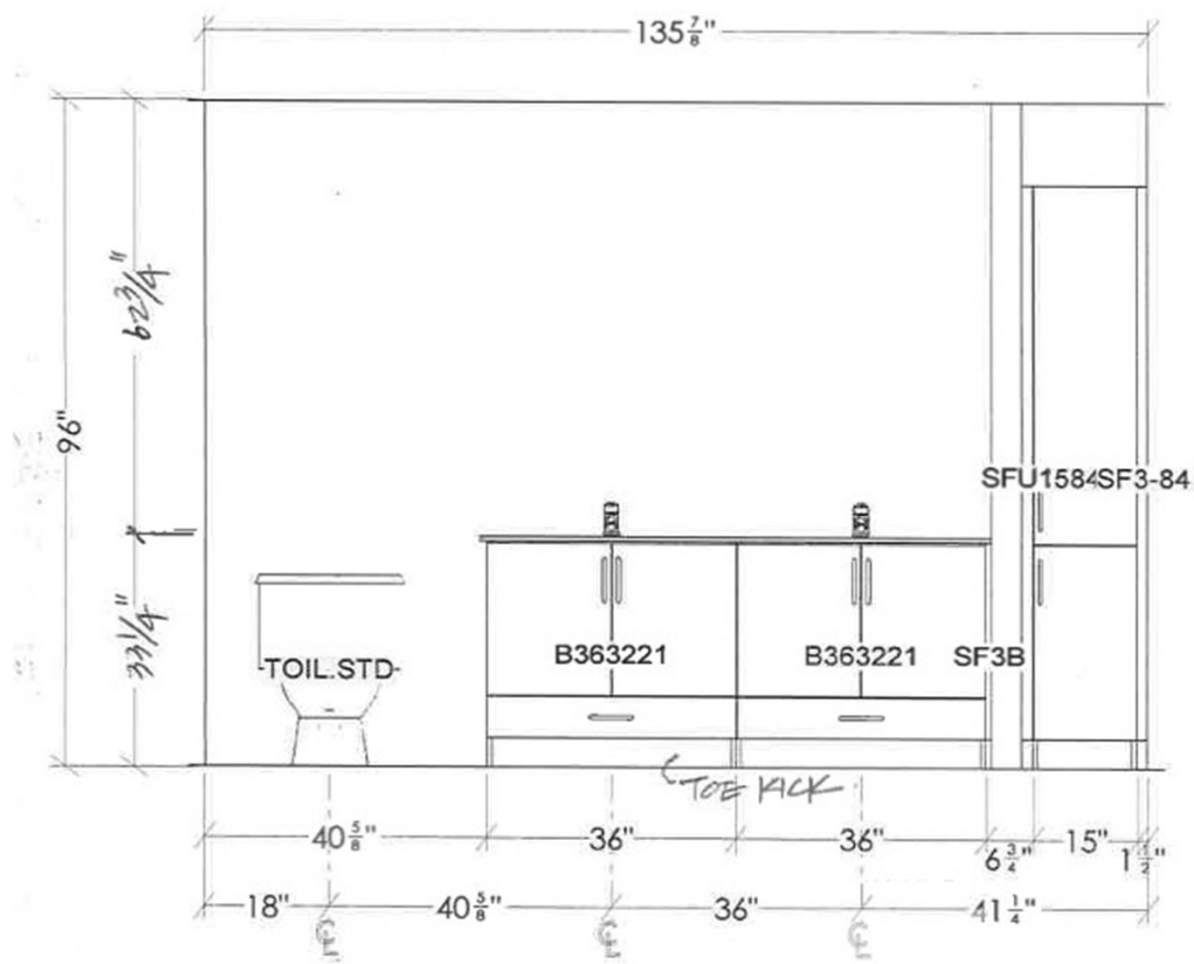

# UNIT B1 EN SUITE BATH

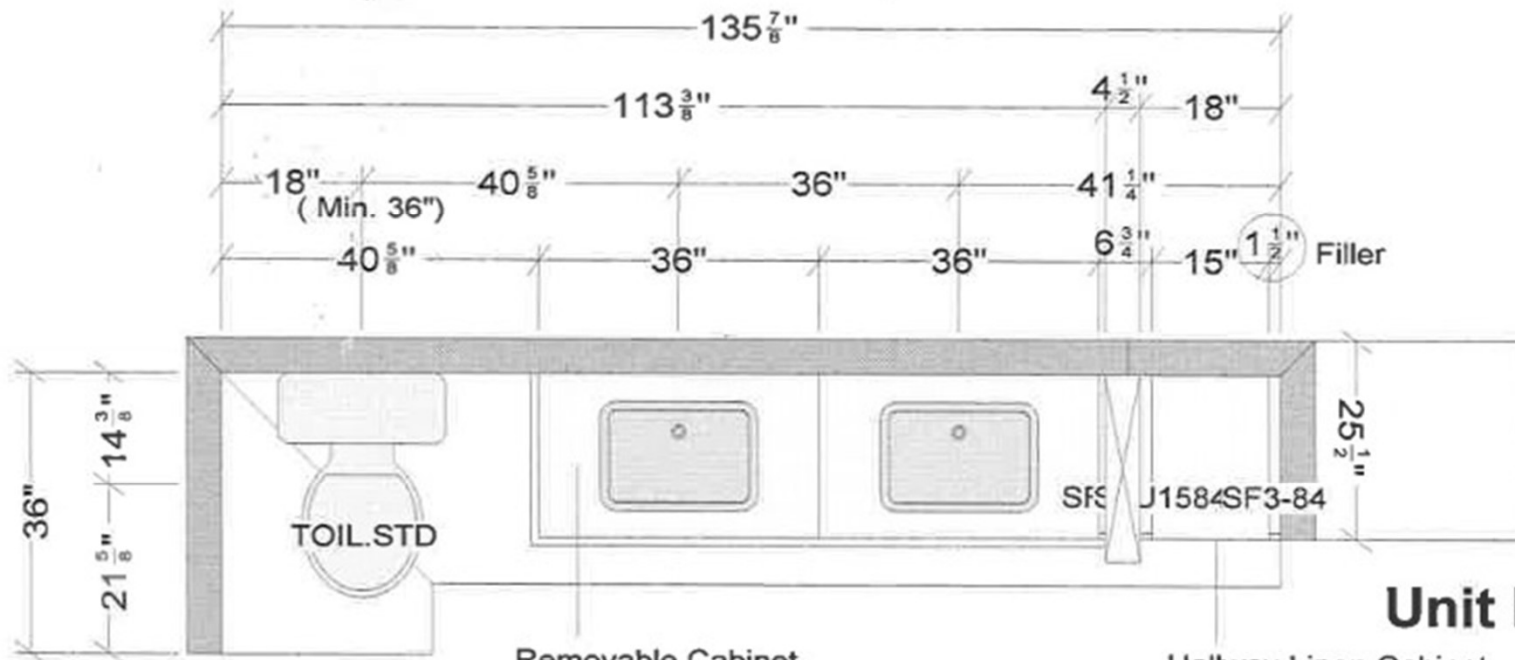

## Unit B1 EN Suite Bath

Removable Cabinet

Hallway Linen Cabinet  
Flat Door with White Matt Color

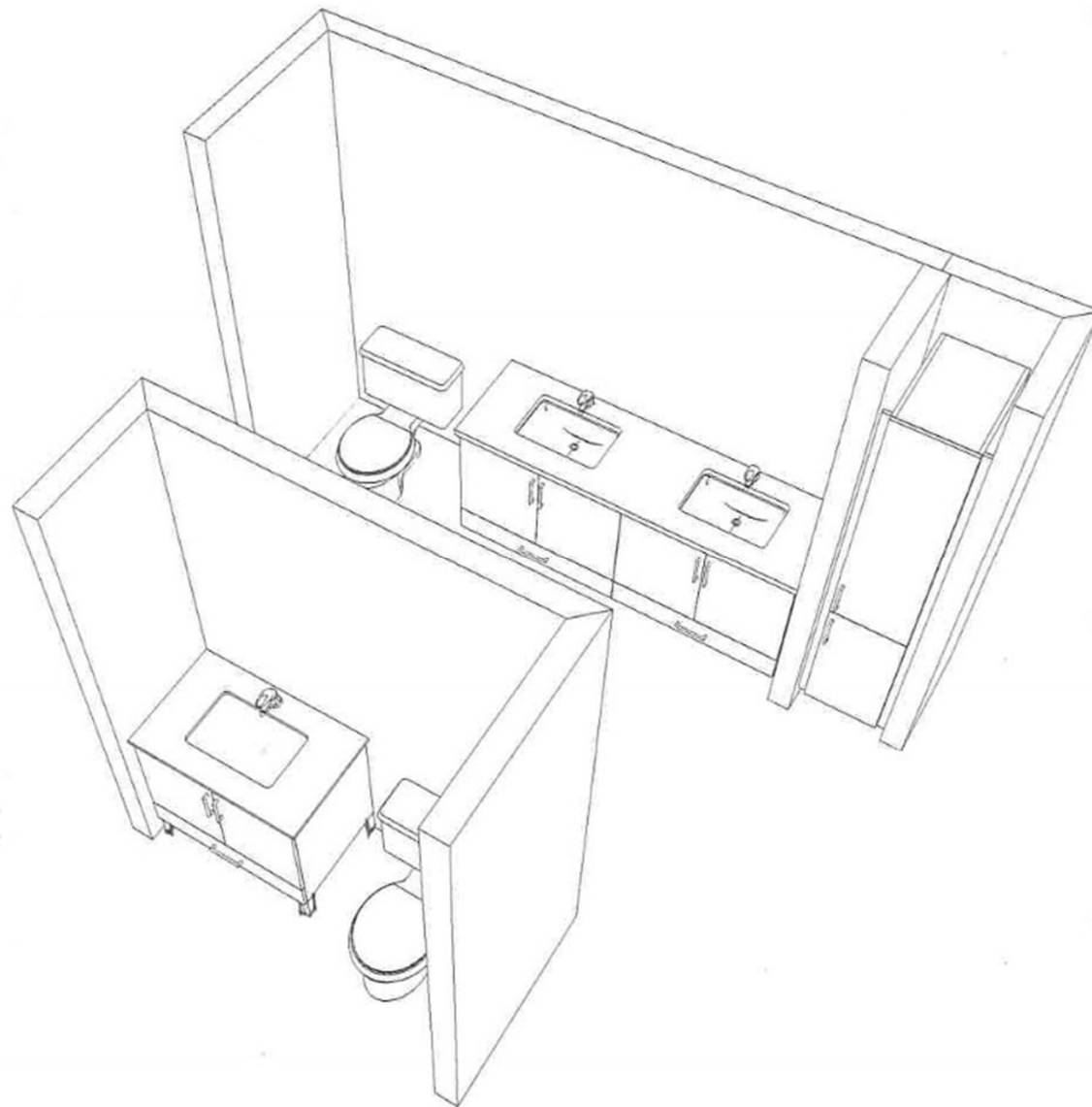

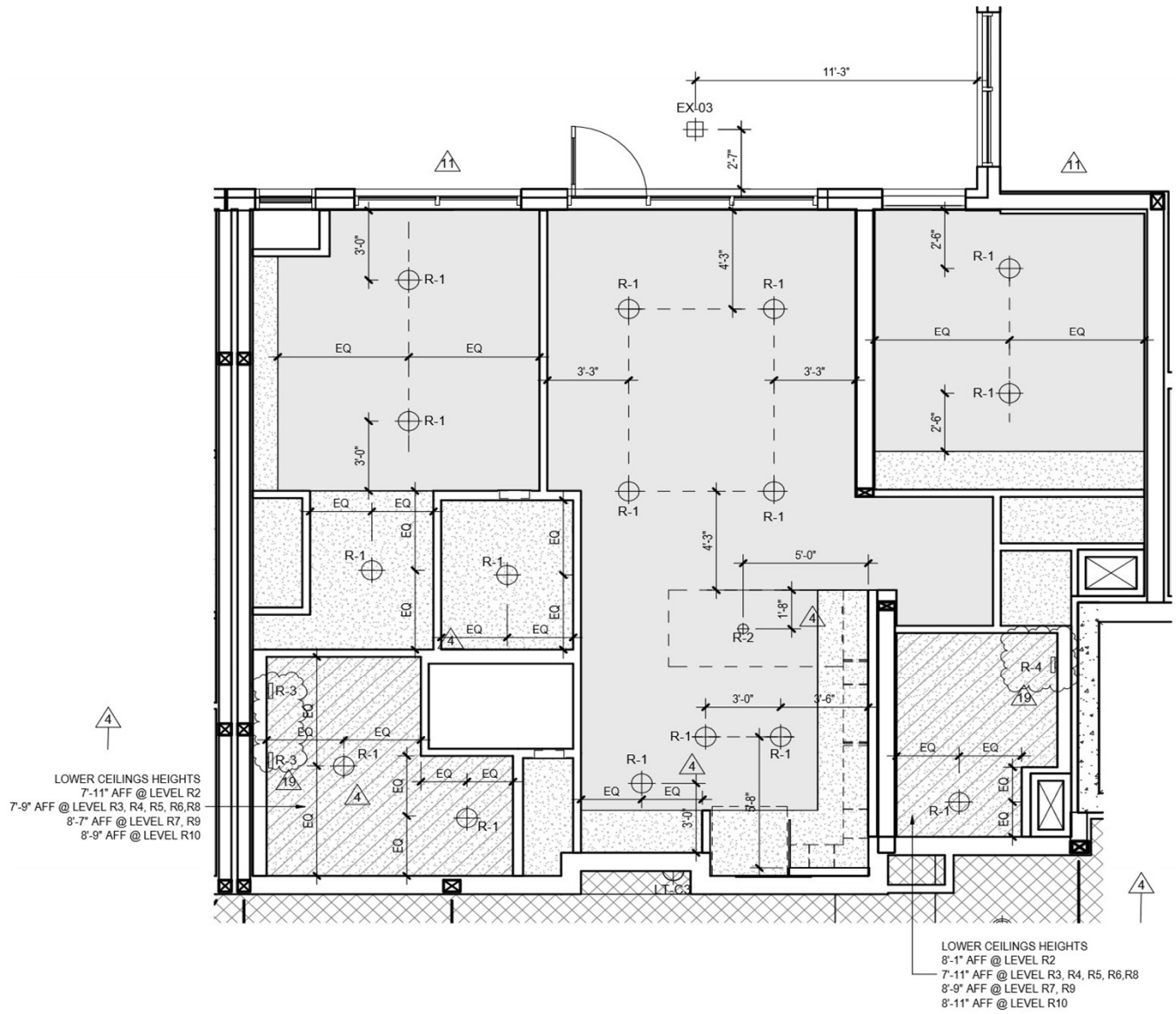

LOWER CEILING HEIGHTS  
 7-11" AFF @ LEVEL R2  
 7-9" AFF @ LEVEL R3, R4, R5, R6, R8  
 8-7" AFF @ LEVEL R7, R9  
 8-9" AFF @ LEVEL R10

LOWER CEILING HEIGHTS  
 8-1" AFF @ LEVEL R2  
 7-11" AFF @ LEVEL R3, R4, R5, R6, R8  
 8-9" AFF @ LEVEL R7, R9  
 8-11" AFF @ LEVEL R10