

B2m1

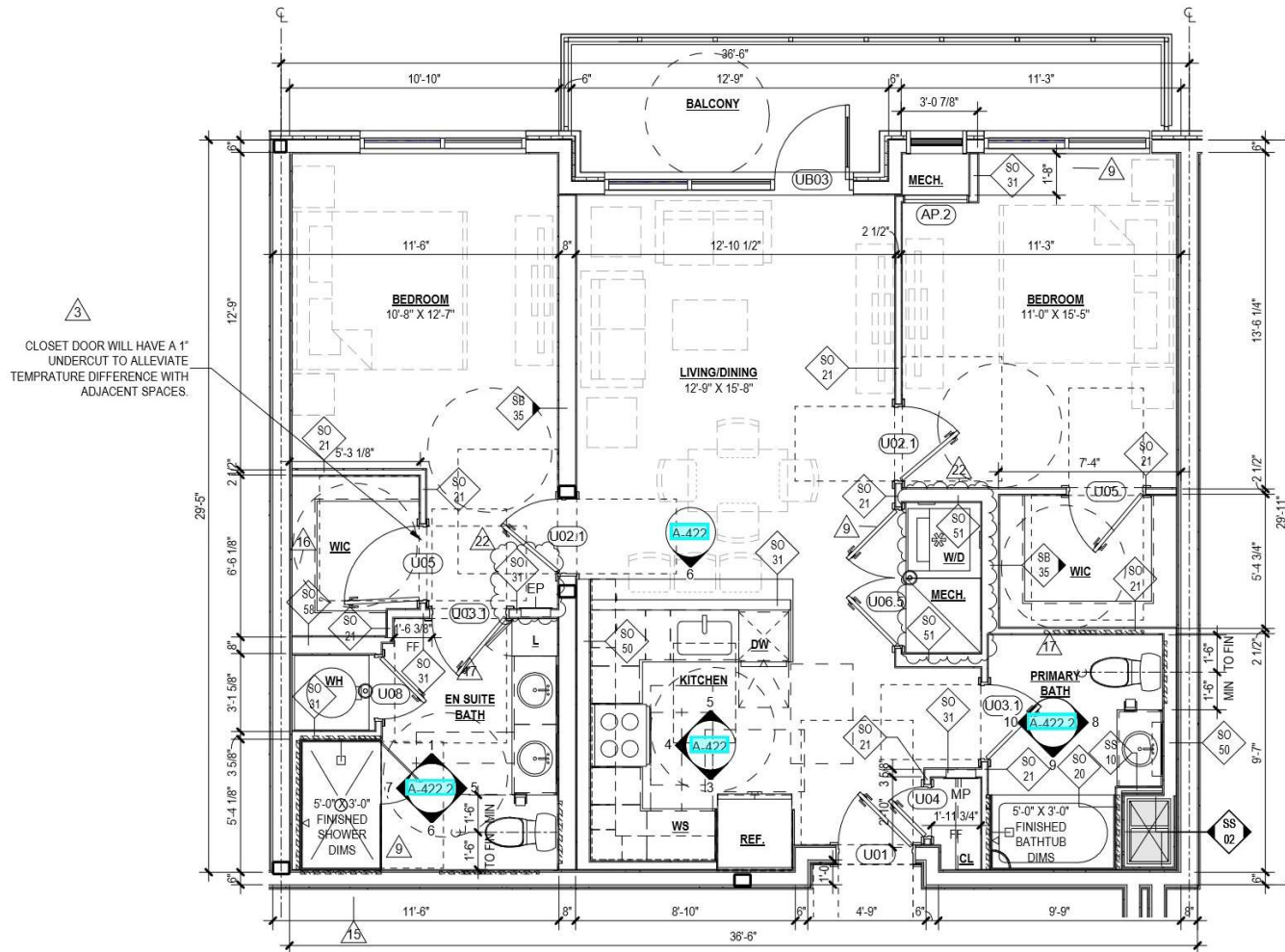

1
A-422.1 UNIT B2M1 PLAN

Scale: 1/4" = 1'-0"

TOTAL 6 UNIT	AREA	1069 GSF
--------------	------	----------

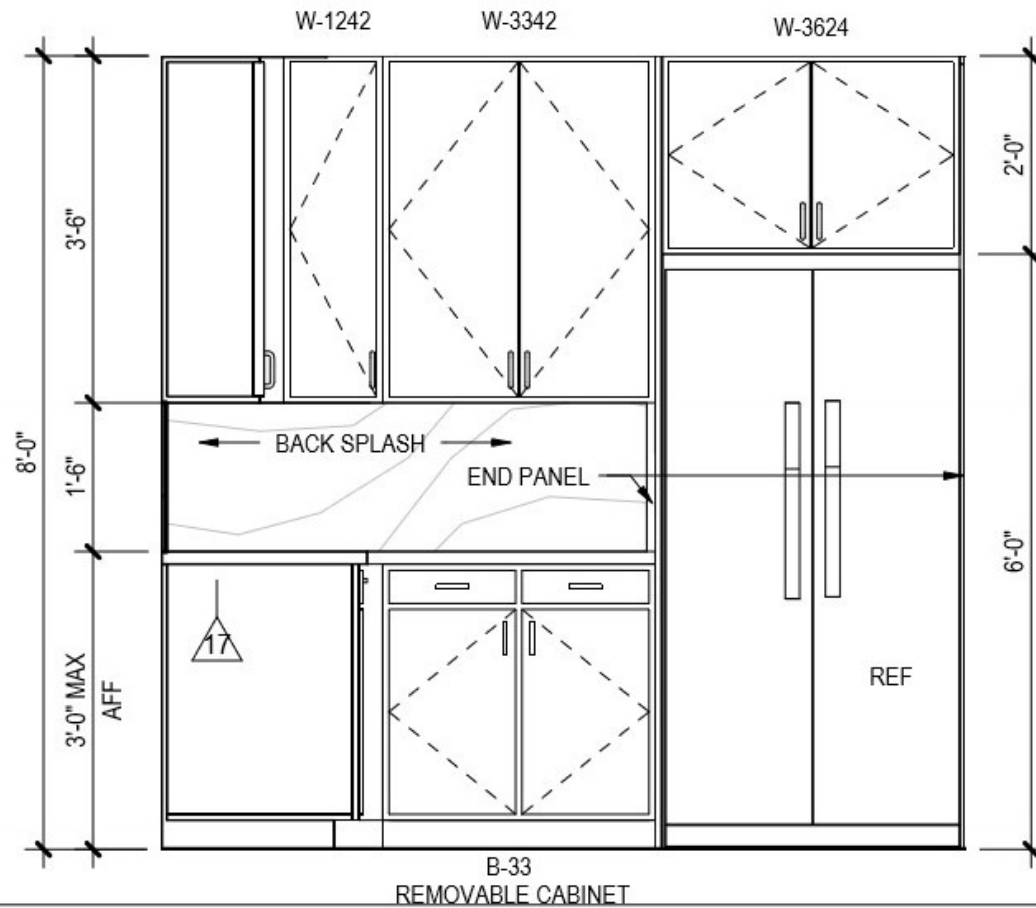

3
A-v22

Scale: 1/2" = 1'-0"

KITCHEN - ELEV 1

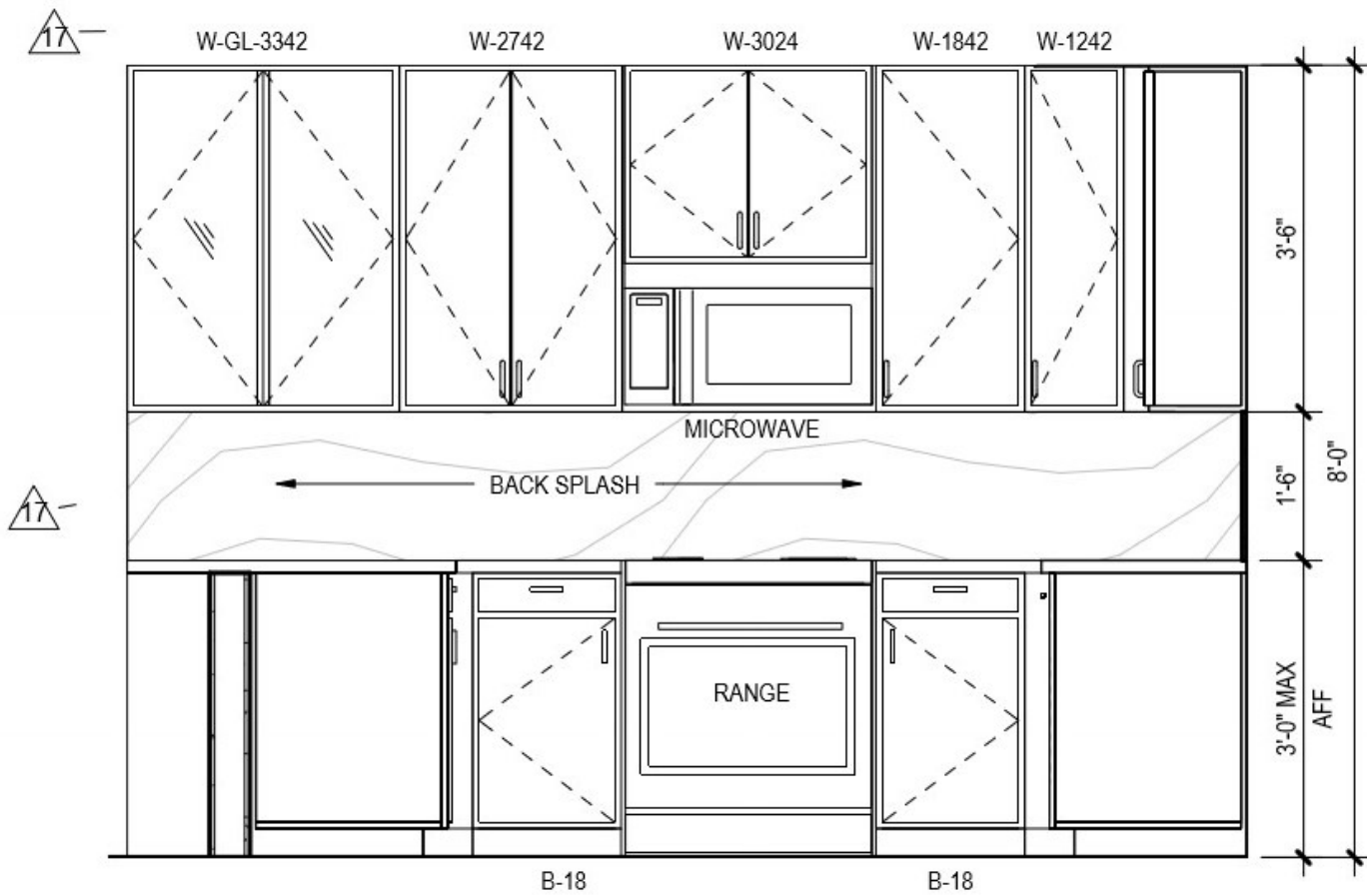

v
A-v22

Scale: 1/2" = 1'-0"

- KITCHEN - ELEV 2

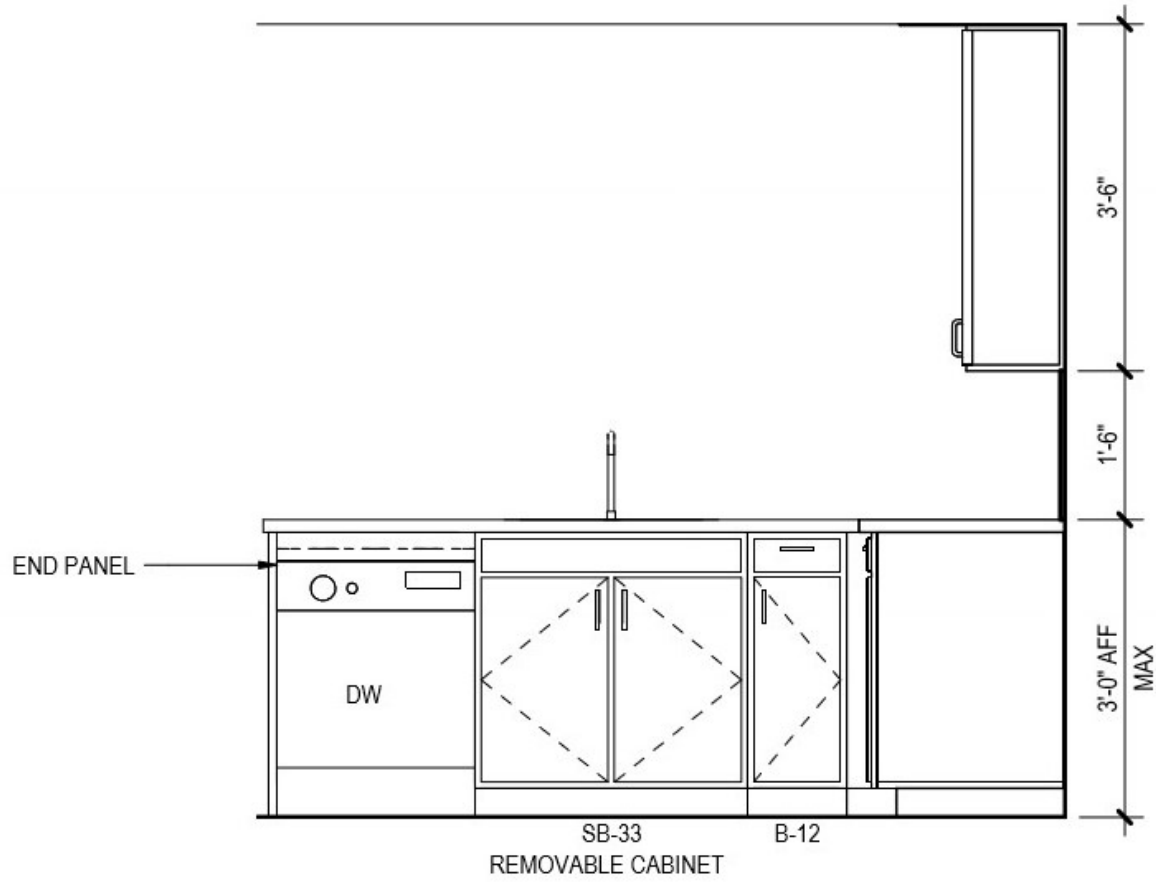

5
A-v22

Scale: 1/2" = 1'-0"

- KITCHEN - ELEV 3

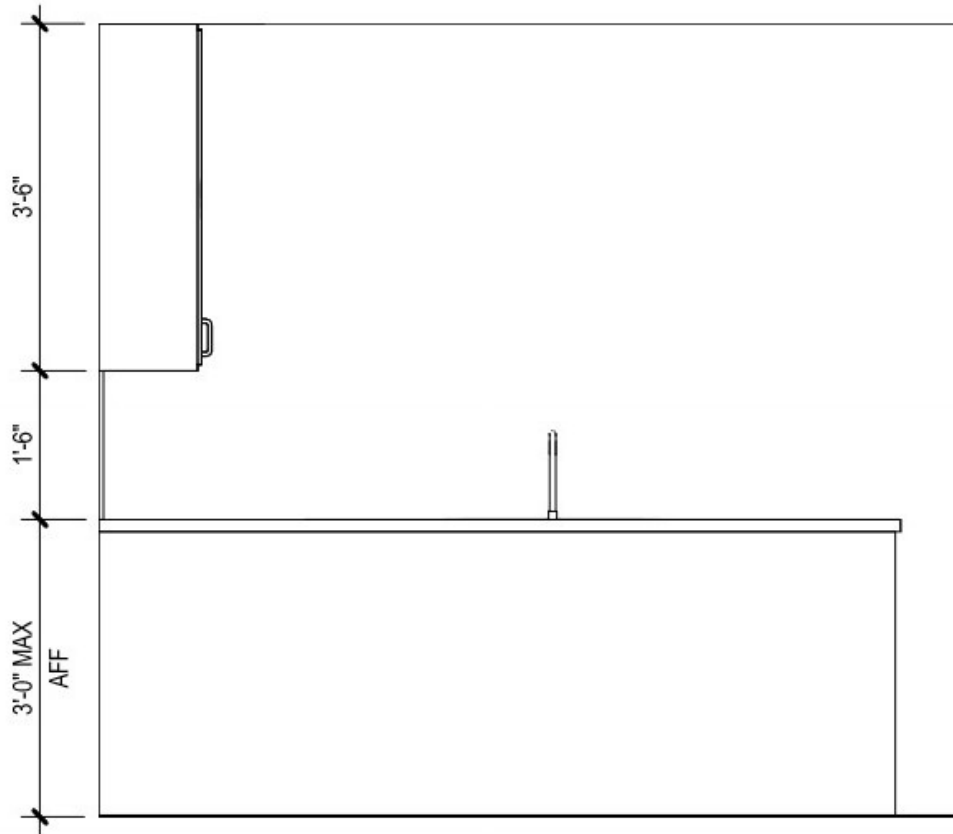

6
A-v22

Scale: 1/2" = 1'-0"

- KITCHEN - ELEV v

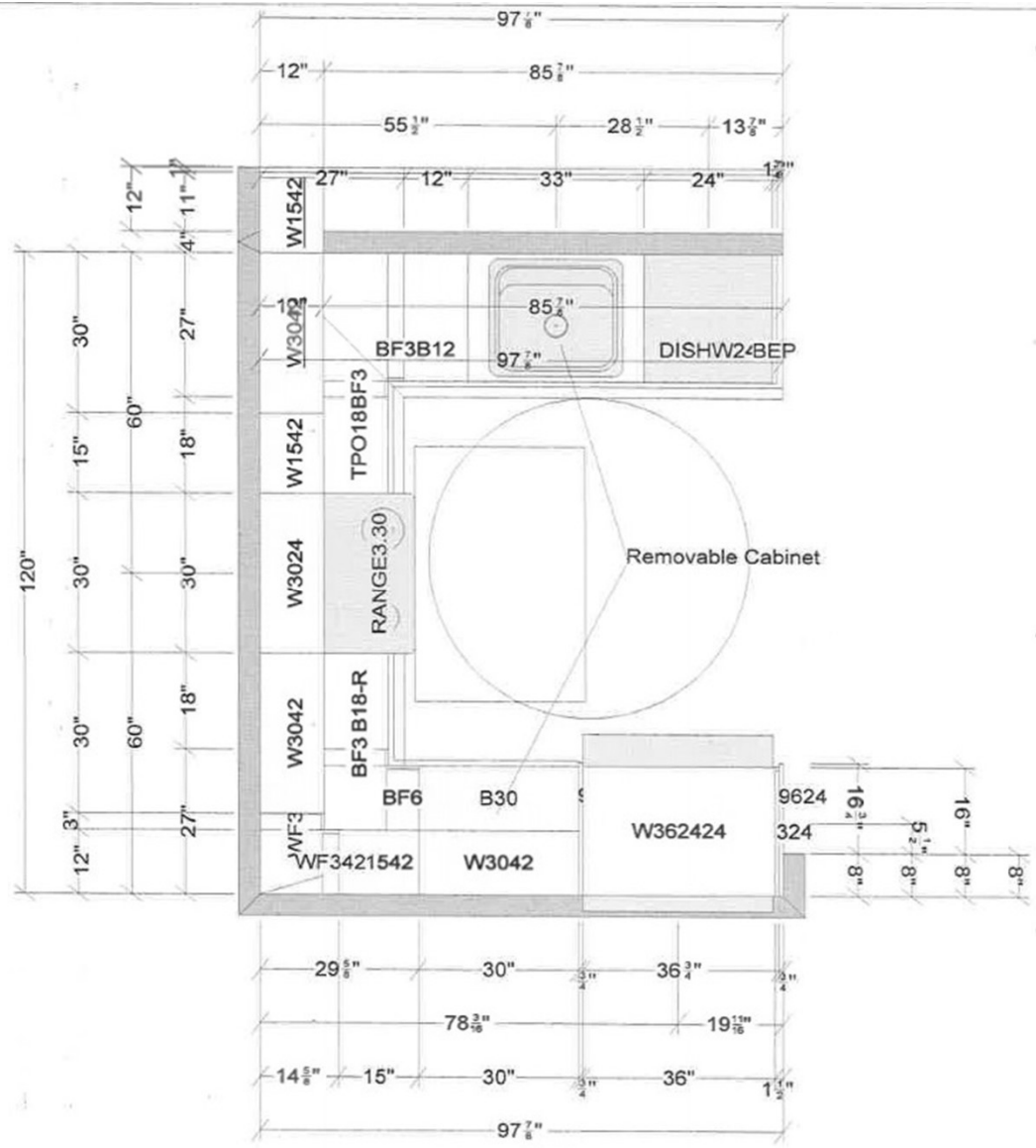

(B2M1-98 7/8")

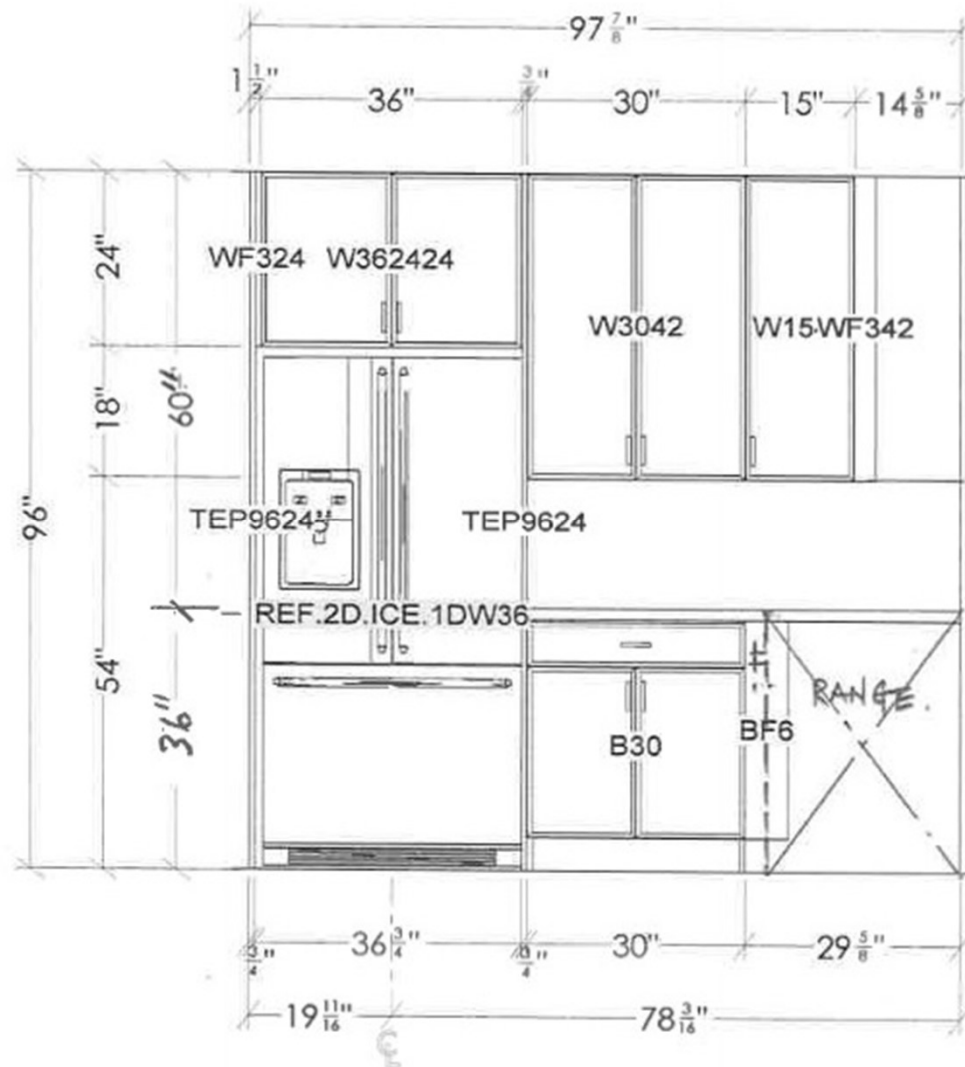

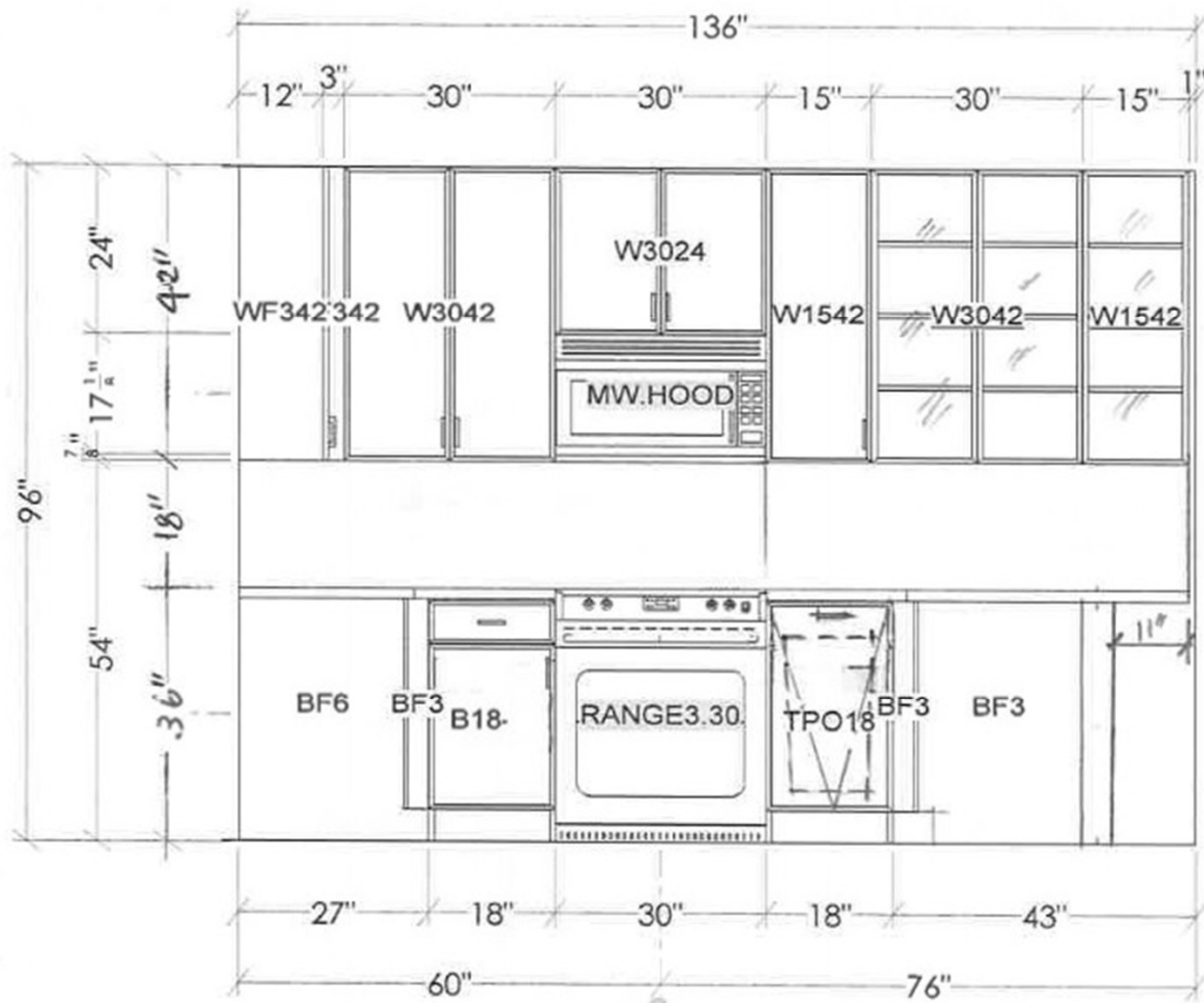

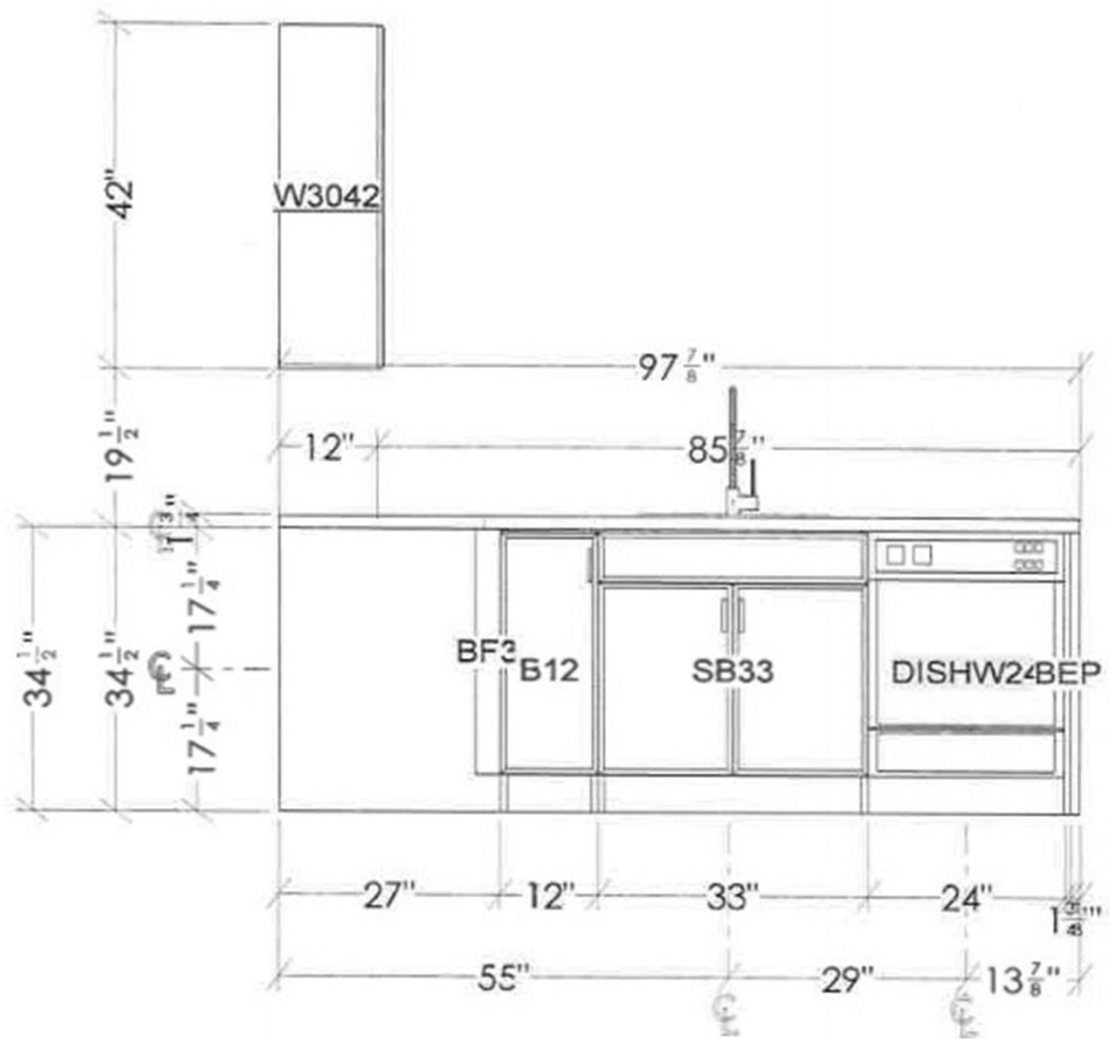

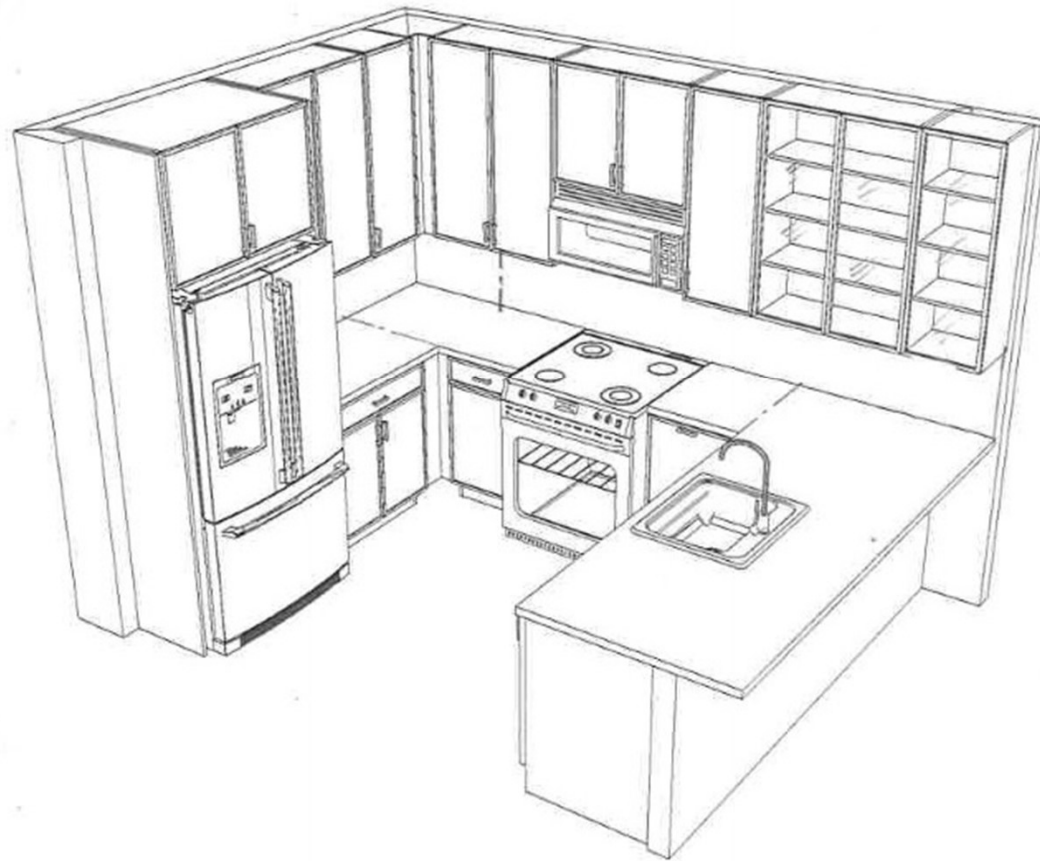

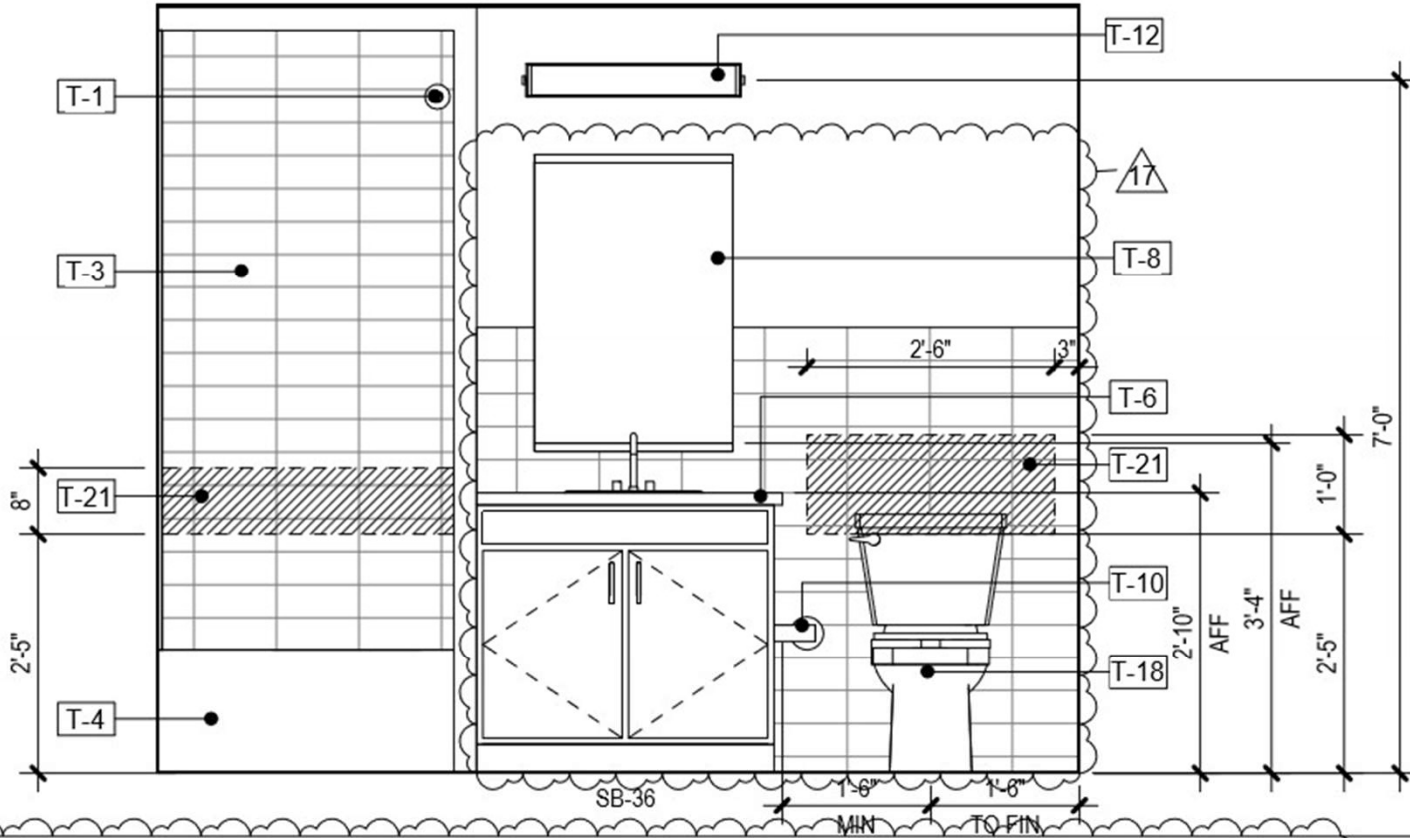

8
A-422.2

Scale: 1/2" = 1'-0"

- PRIMARY BATH - ELEV 1

17

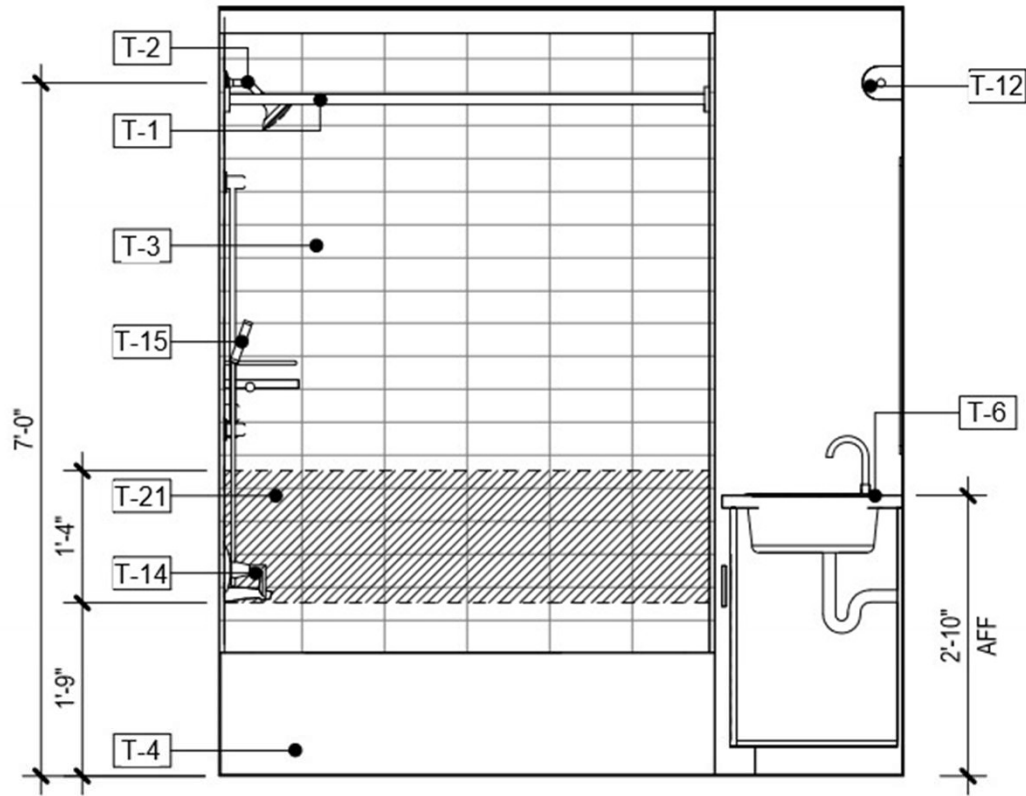

9

A-422.2

Scale: 1/2" = 1'-0"

- PRIMARY BATH - ELEV 2

17

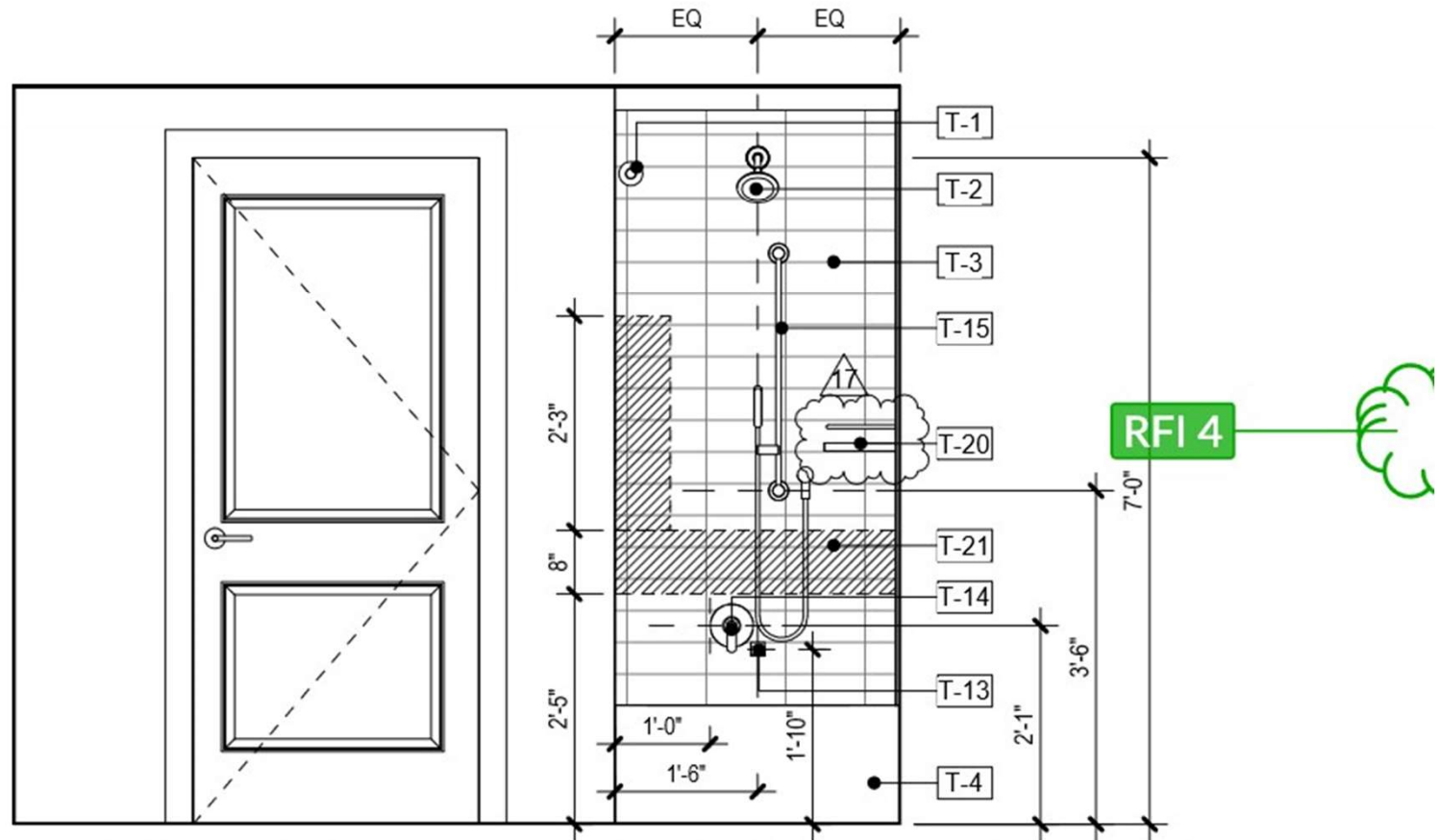

10

A-422.2

Scale: 1/2" = 1'-0"

- PRIMARY BATH - ELEV 3

17

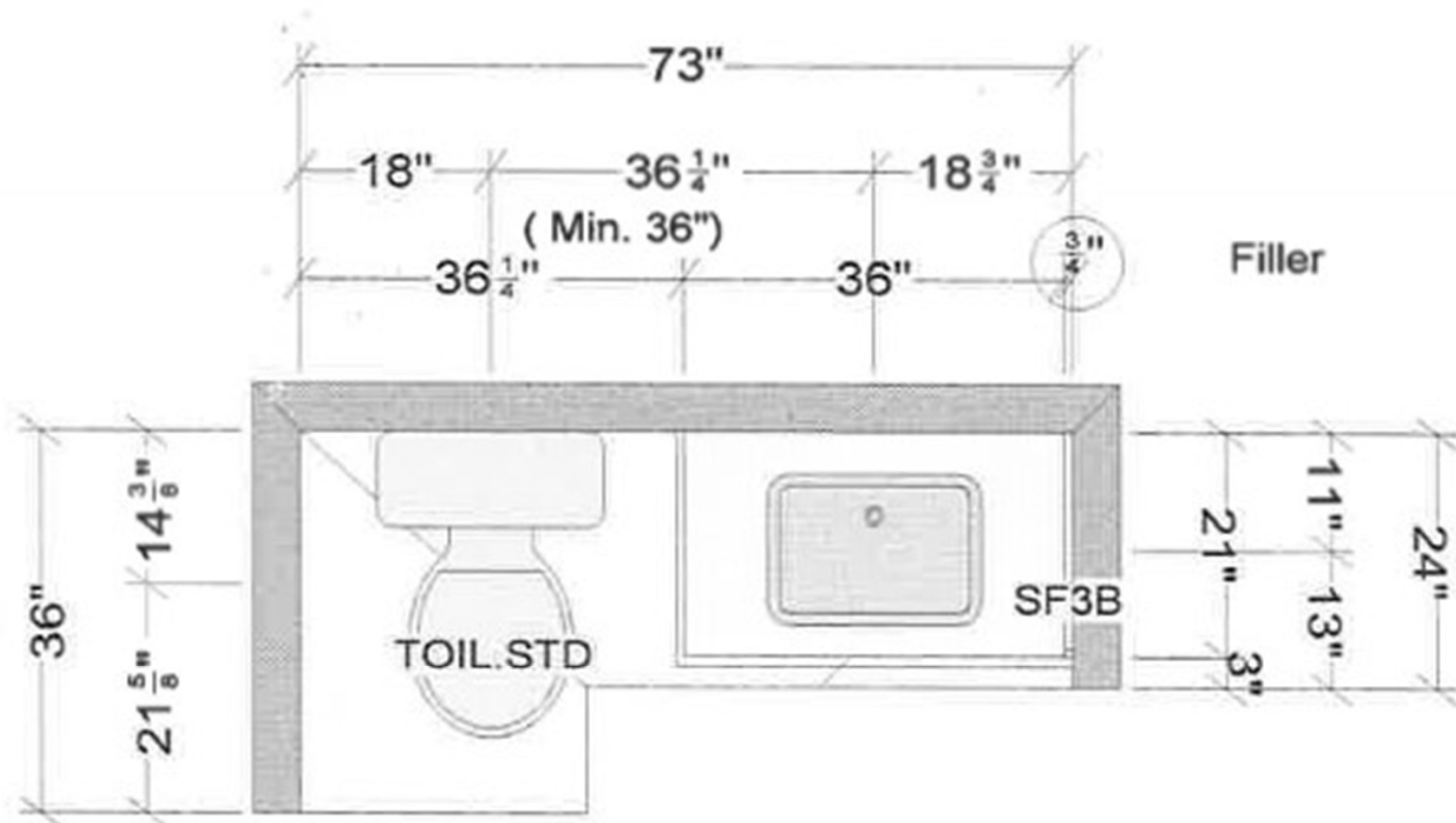

Unit B2M1, B2M3 Primary Bath

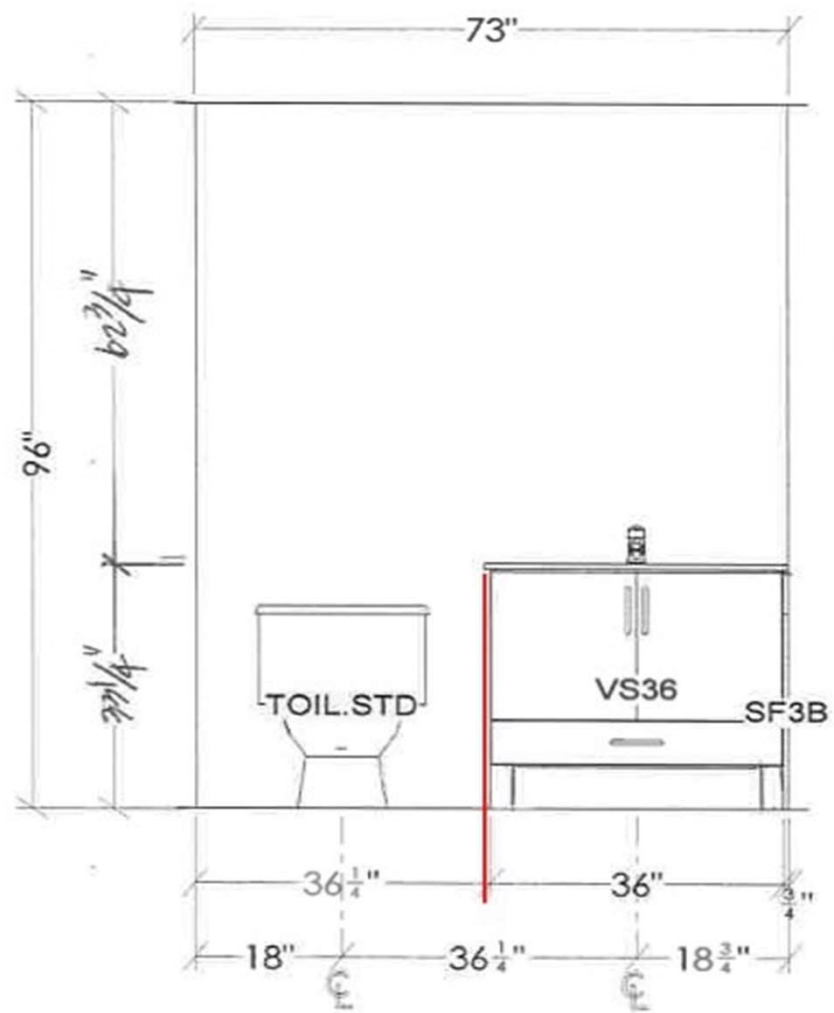

Primary Bath

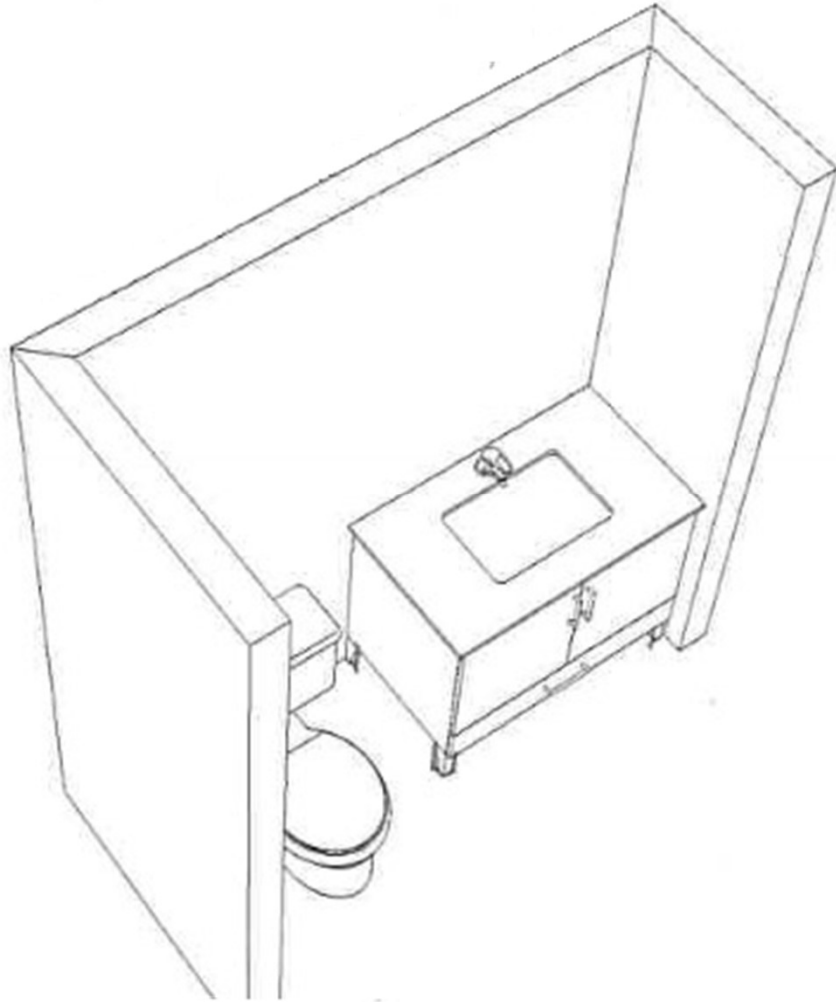

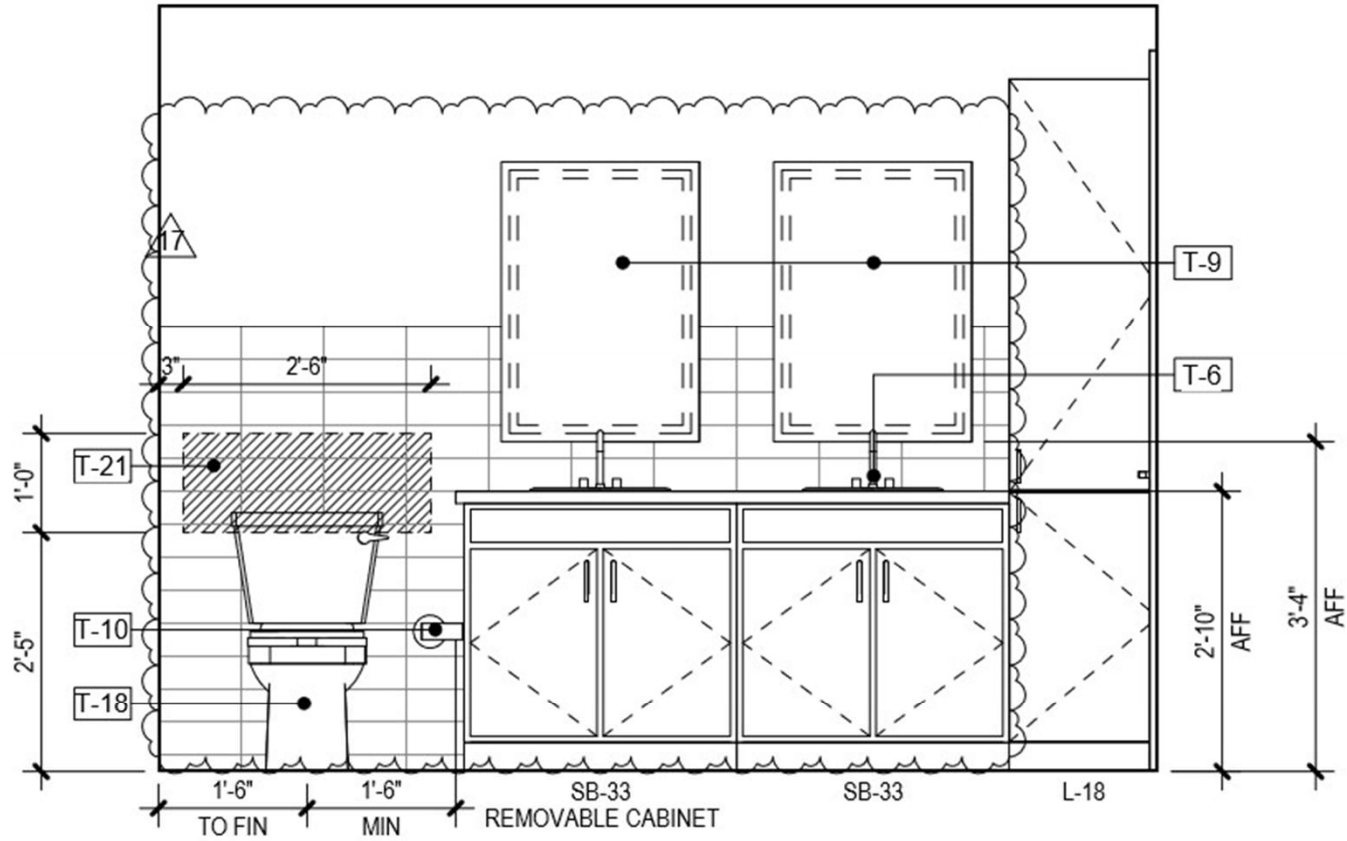

5
A-422.2

Scale: 1/2" = 1'-0"

- EN SUITE BATH - ELEV 1

17

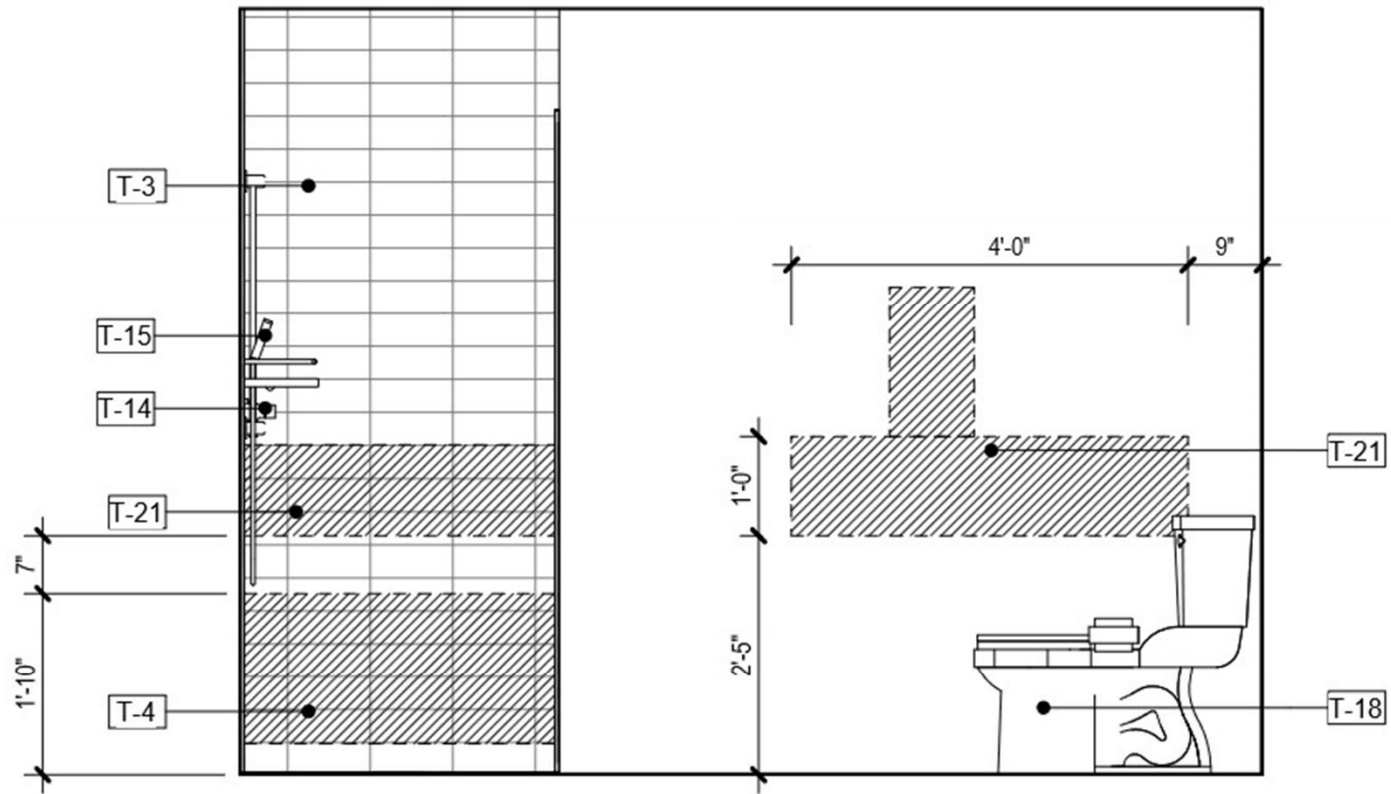

6
 A-422.2 Scale: 1/2" = 1'-0" - EN SUITE BATH - ELEV 2 17

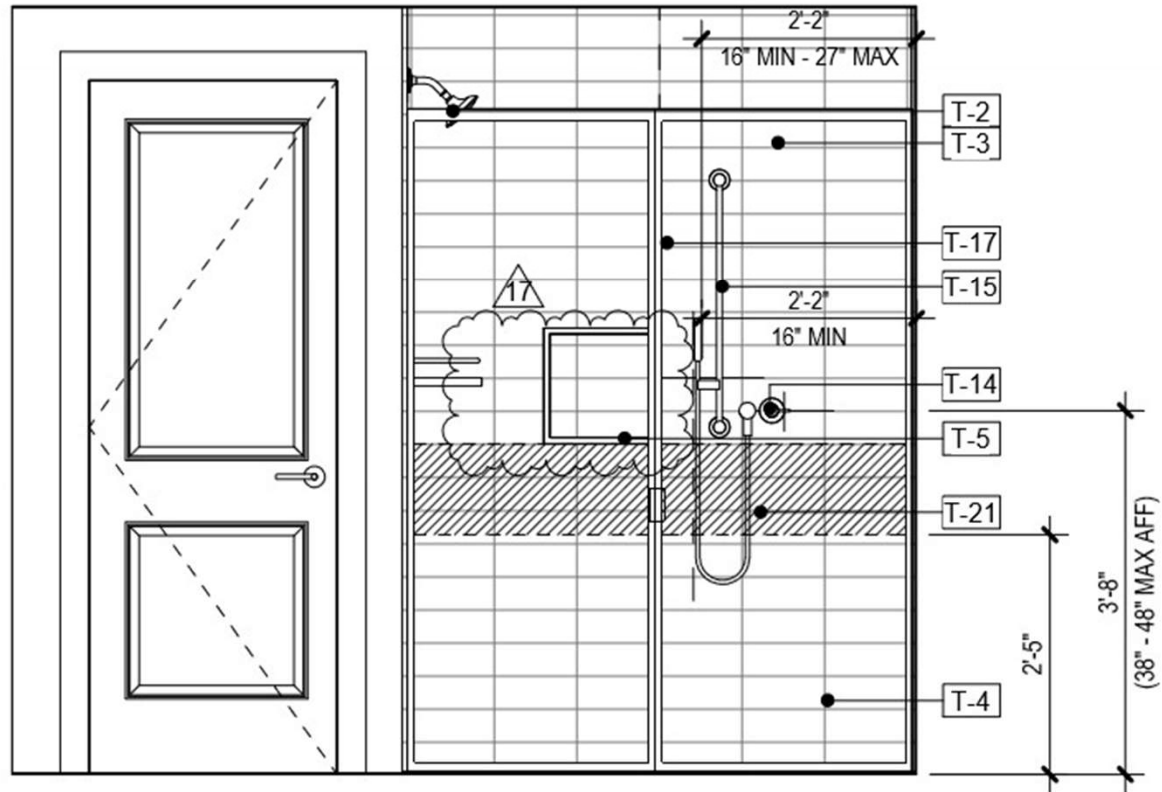

7
A-42 2.2

Scale: 1/2" = 1'-0"

- EN SUITE BATH - ELEV 3



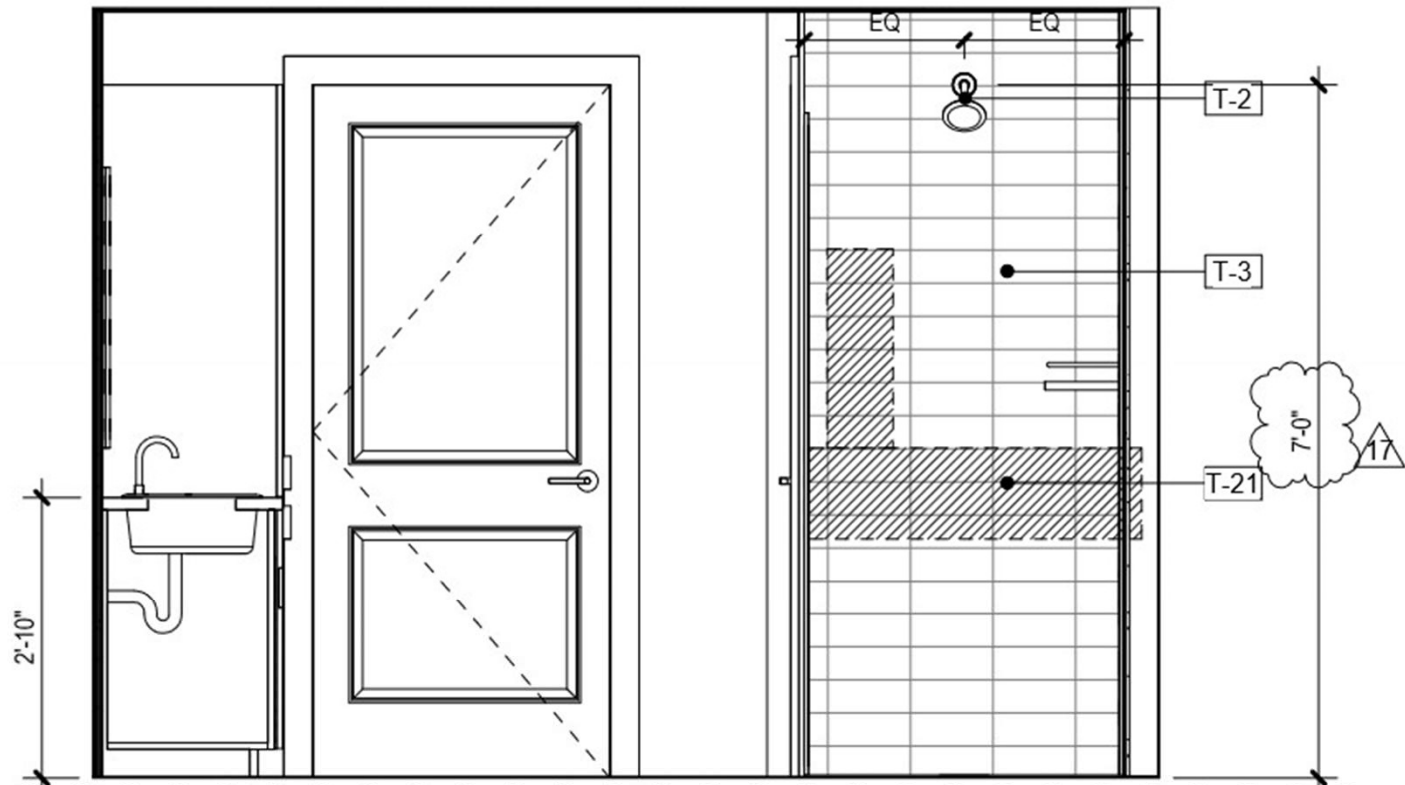

1
A-422.2

Scale: 1/2" = 1'-0"

- EN SUITE BATH - ELEV 4

17

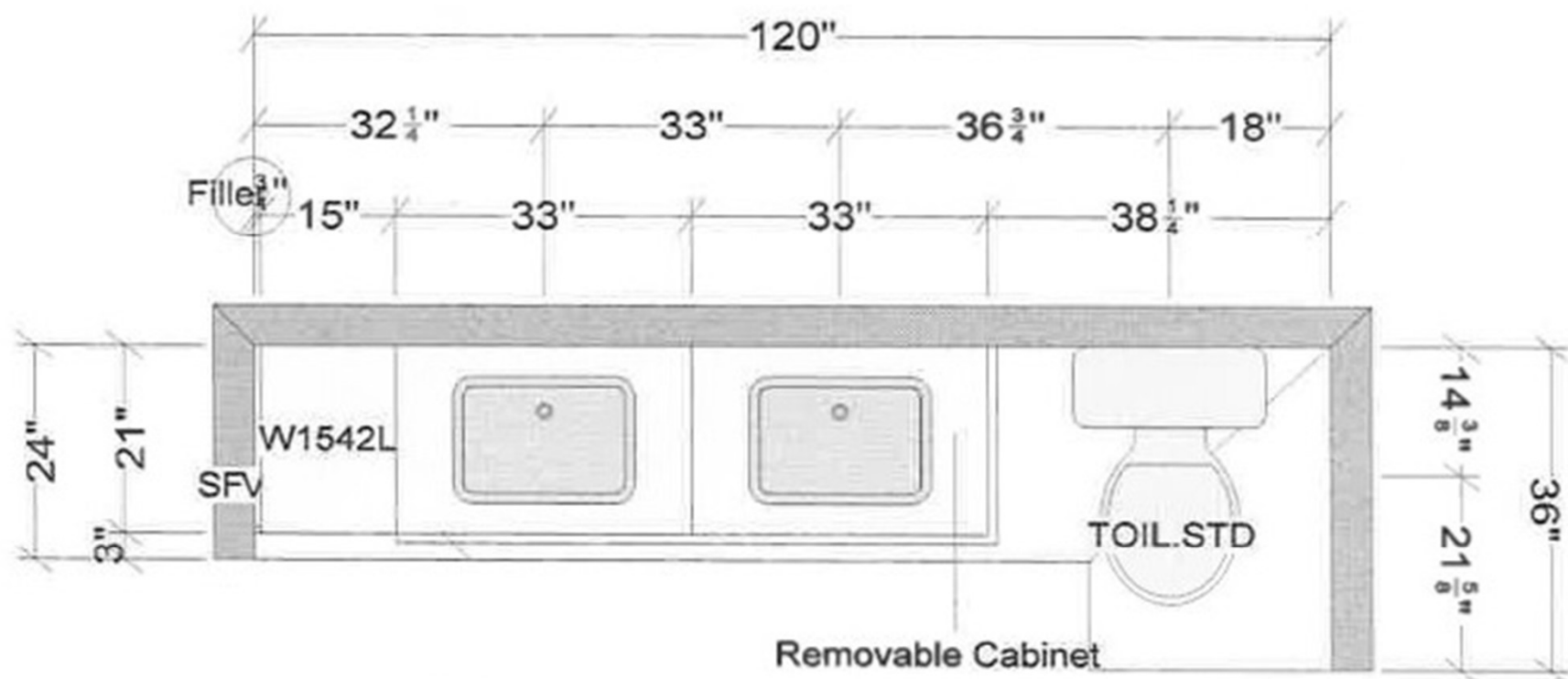

Unit B2M1, B2M3 EN Suite Bath

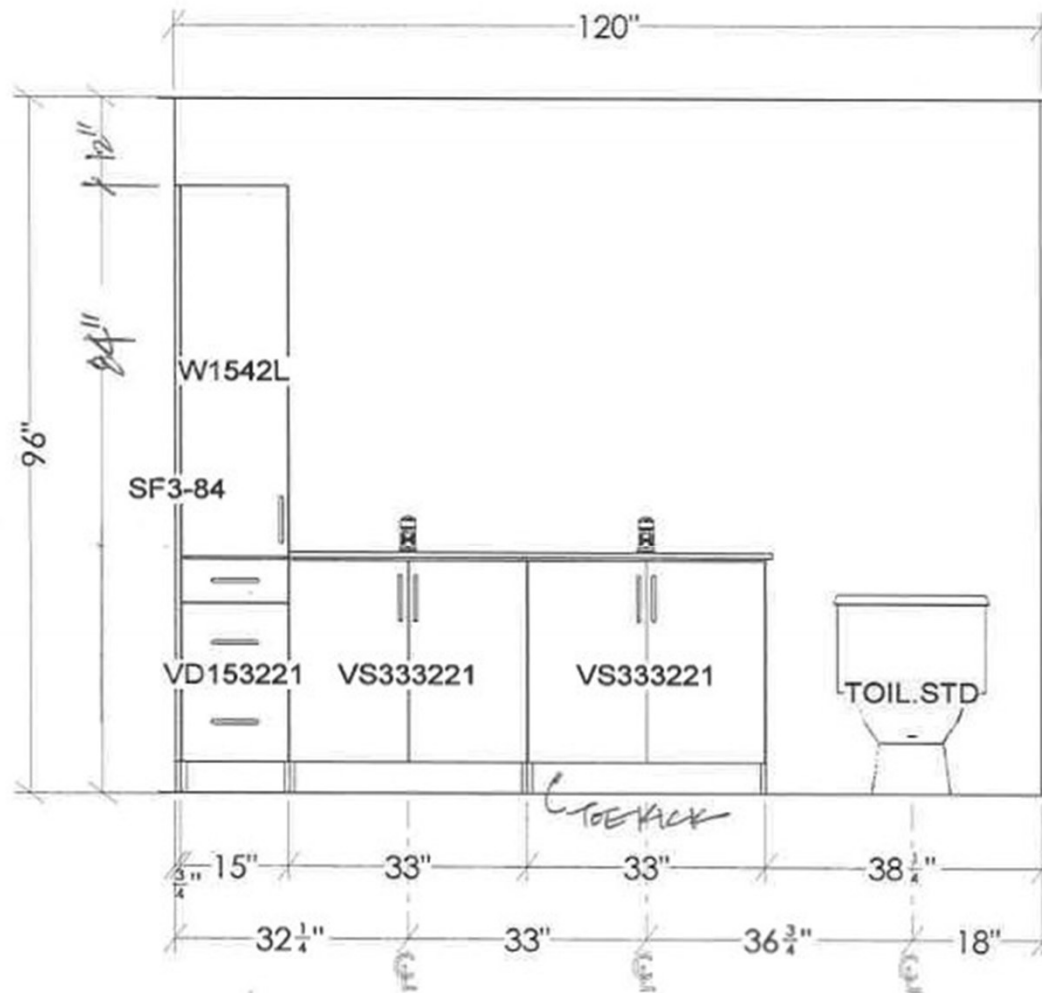

UNIT B2M1, B2M3 EN SUITE BATH

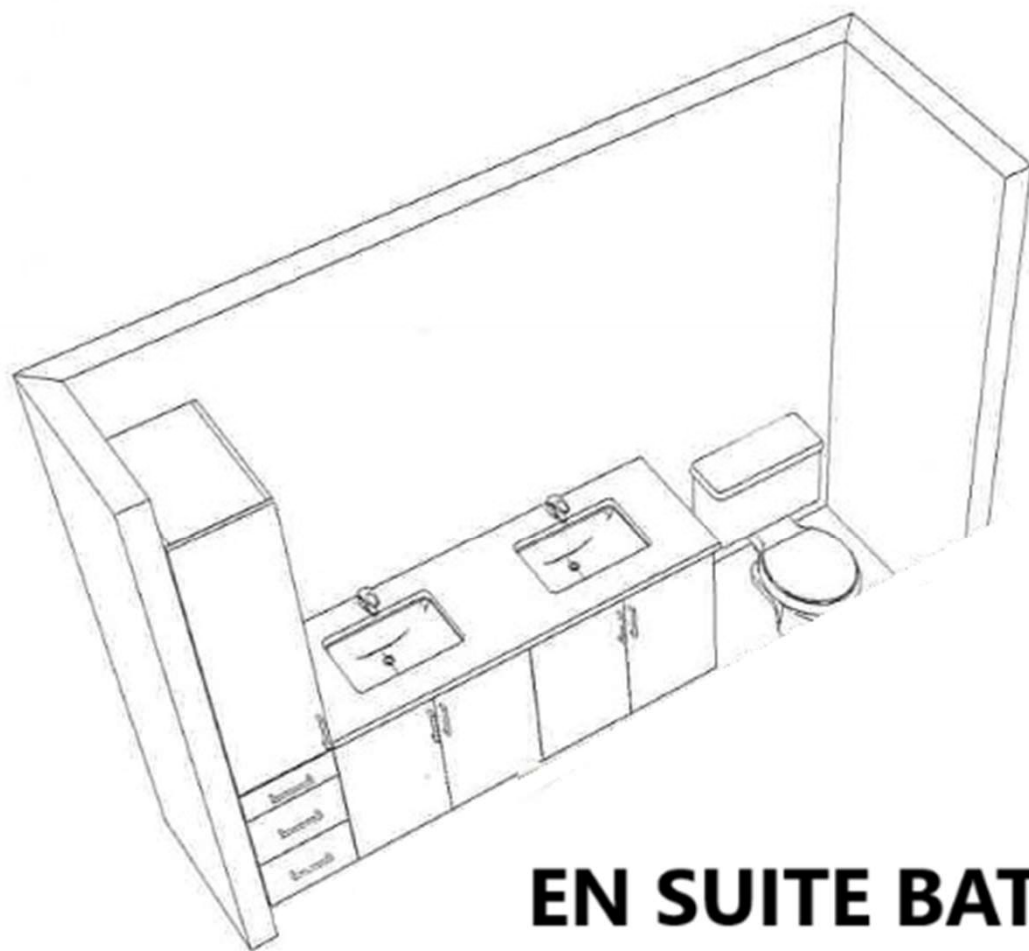

EN SUITE BATH

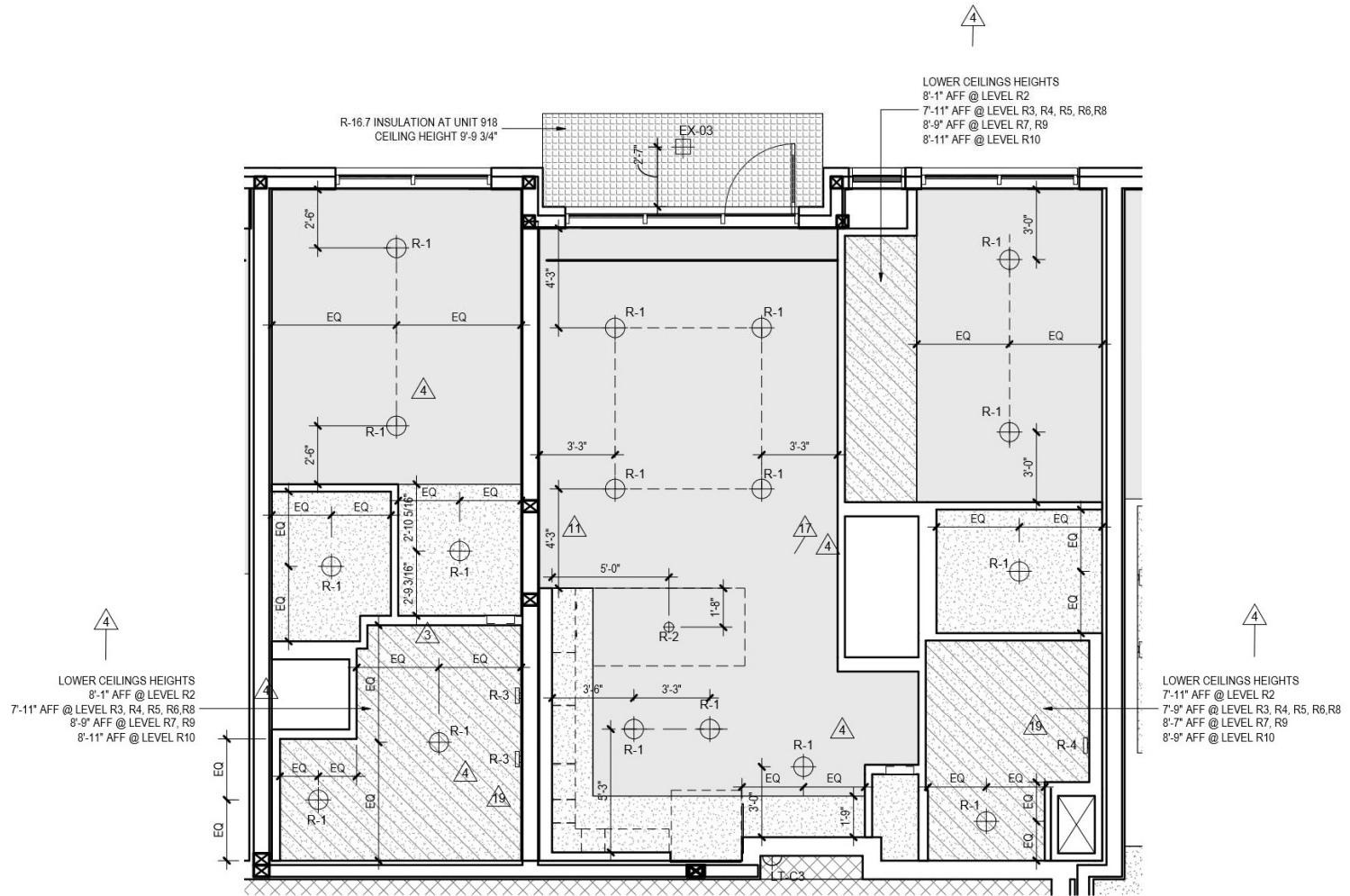

2
A-422.1 UNIT B2M1 RCP
Scale: 1/4" = 1'-0"