

**B3**

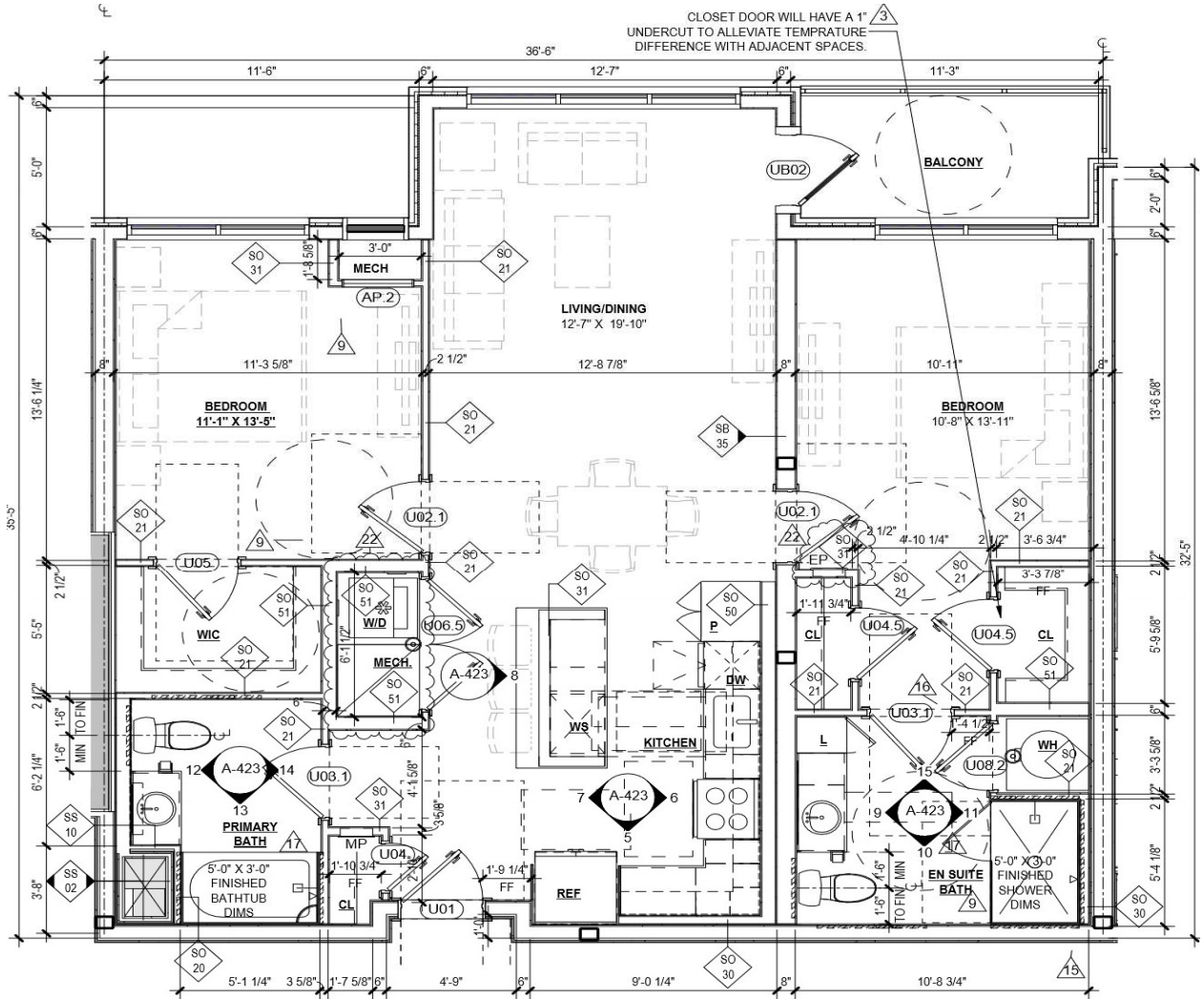

CLOSET DOOR WILL HAVE A 1" <sup>3</sup>/<sub>4</sub> UNDERCUT TO ALLEVIATE TEMPERATURE DIFFERENCE WITH ADJACENT SPACES.

**1**  
A-423

## UNIT B3 PLAN

Scale: 1/4" = 1'-0"

TOTAL 9 UNIT

AREA	1160 GSF

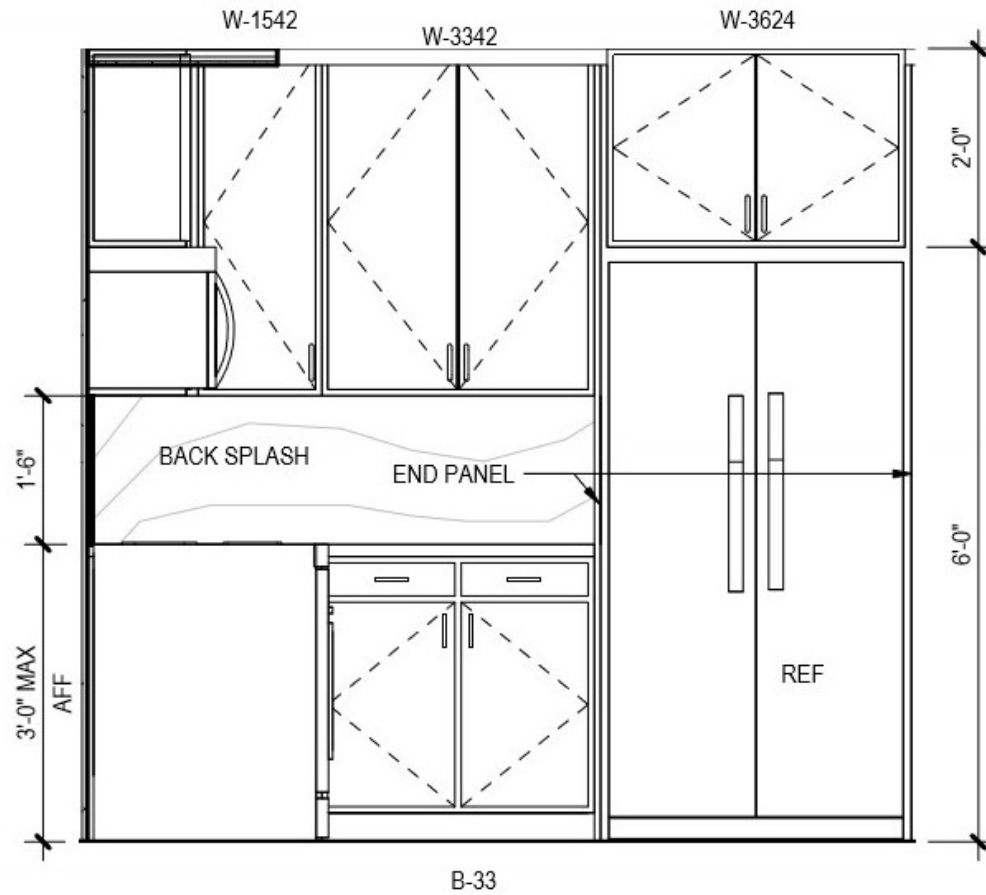

5  
A-423

# UNIT B3 - KITCHEN - ELEV 1

Scale: 1/2" = 1'-0"

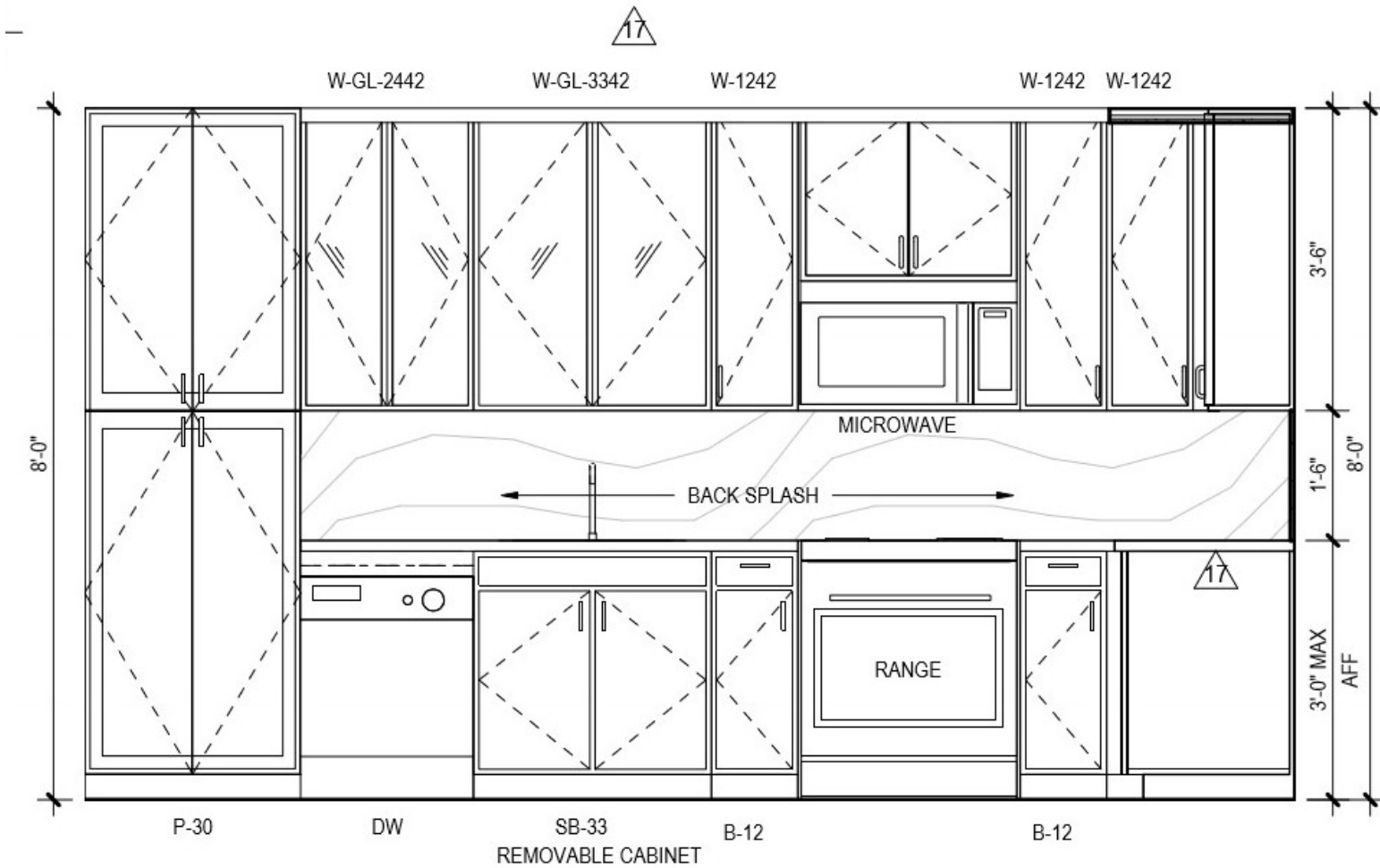

6  
A-423

# UNIT B3 - KITCHEN - ELEV 2

Scale: 1/2" = 1'-0"

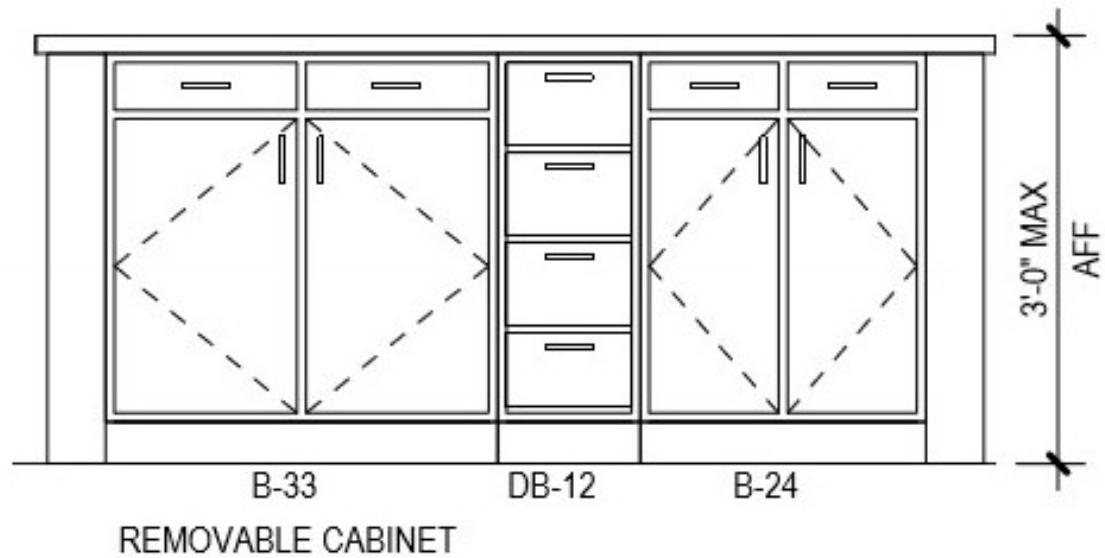

7  
A-423

## UNIT B3 - KITCHEN - ELEV 3

Scale: 1/2" = 1'-0"



---

8  
A-423

# UNIT B3 - KITCHEN - ELEV 4

---

Scale: 1/2" = 1'-0"

---

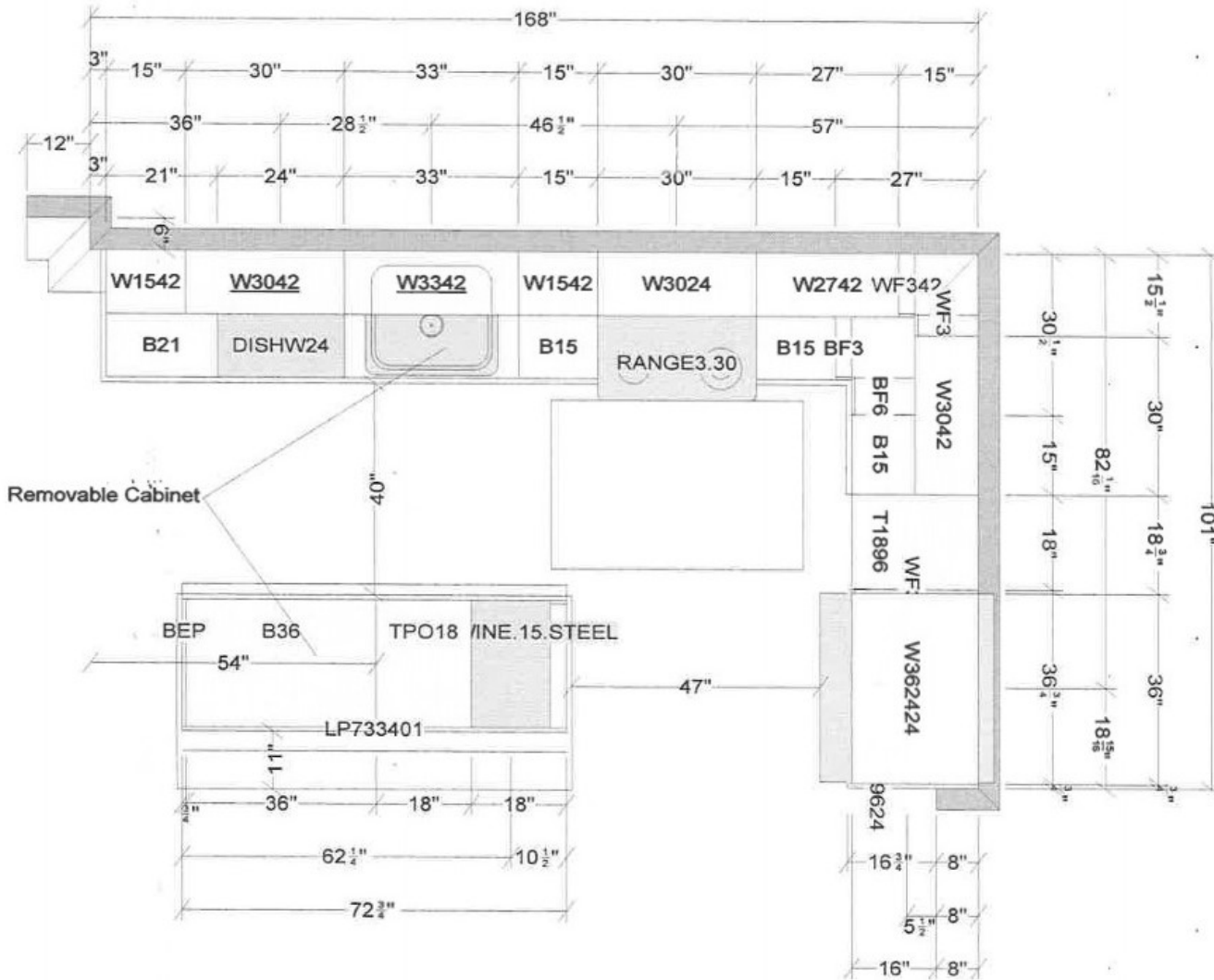

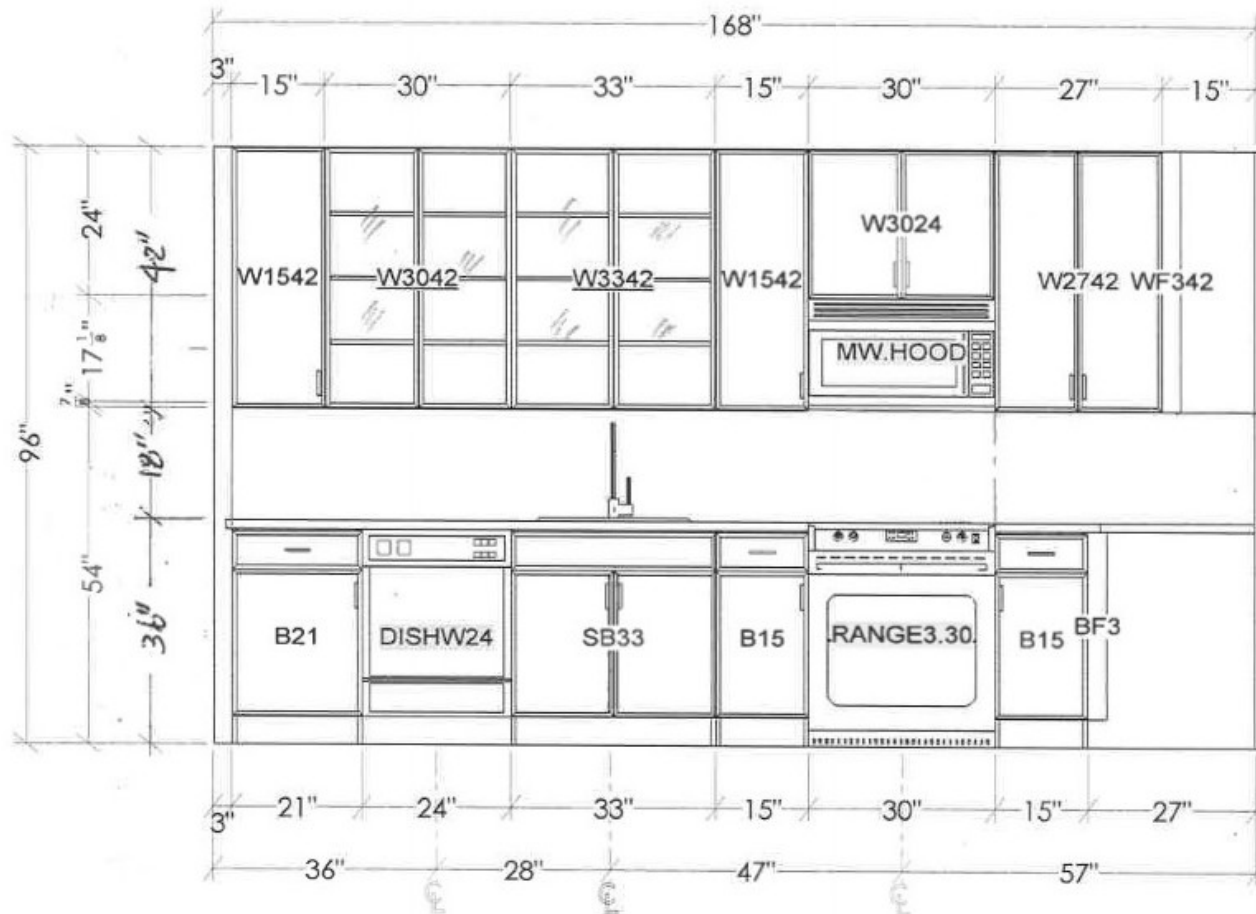



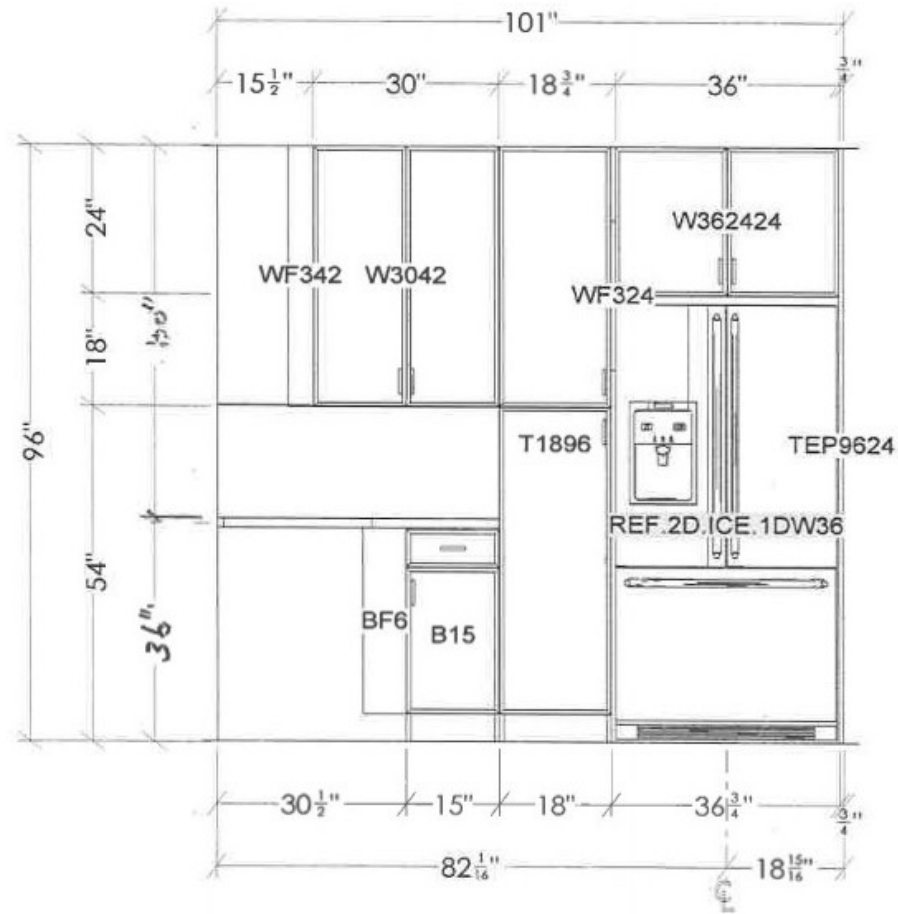

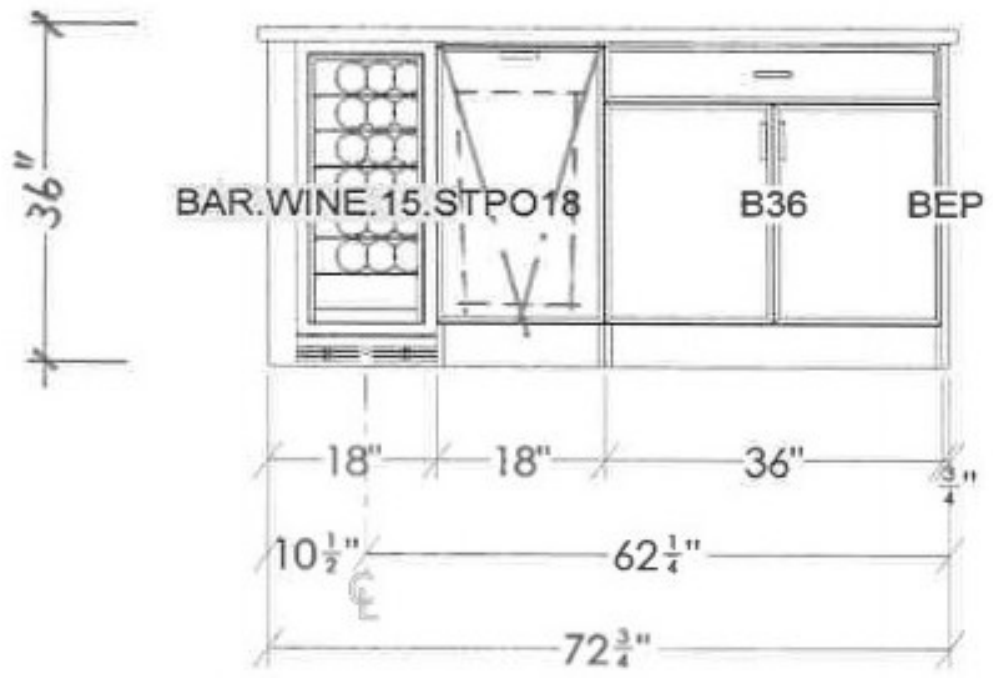



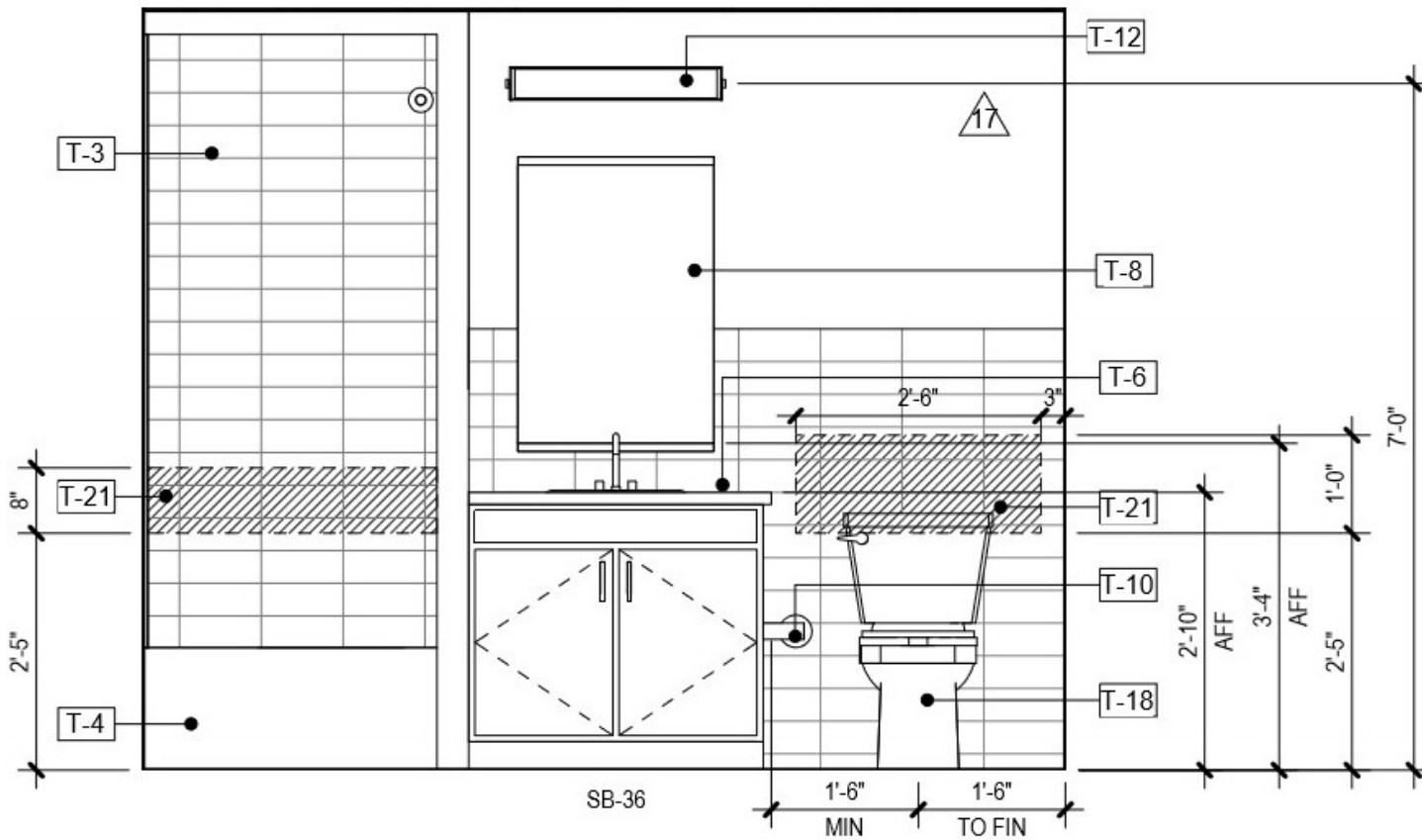

12  
A-423

# UNIT B3 - PRIMARY BATH - ELEV 1

Scale: 1/2" = 1'-0"

17

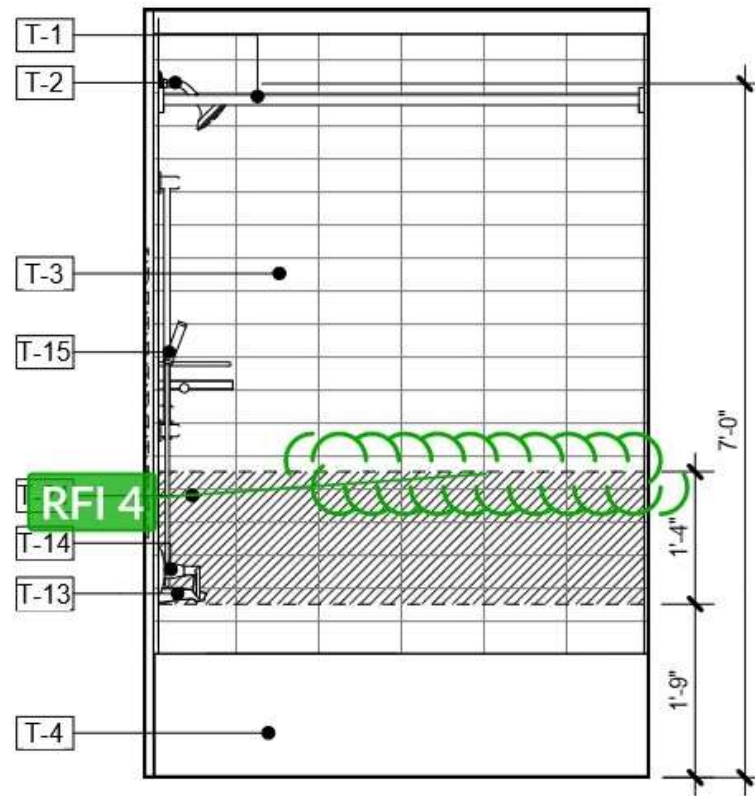

13  
A-423

# UNIT B3 - PRIMARY BATH - ELEV 2

Scale: 1/2" = 1'-0"

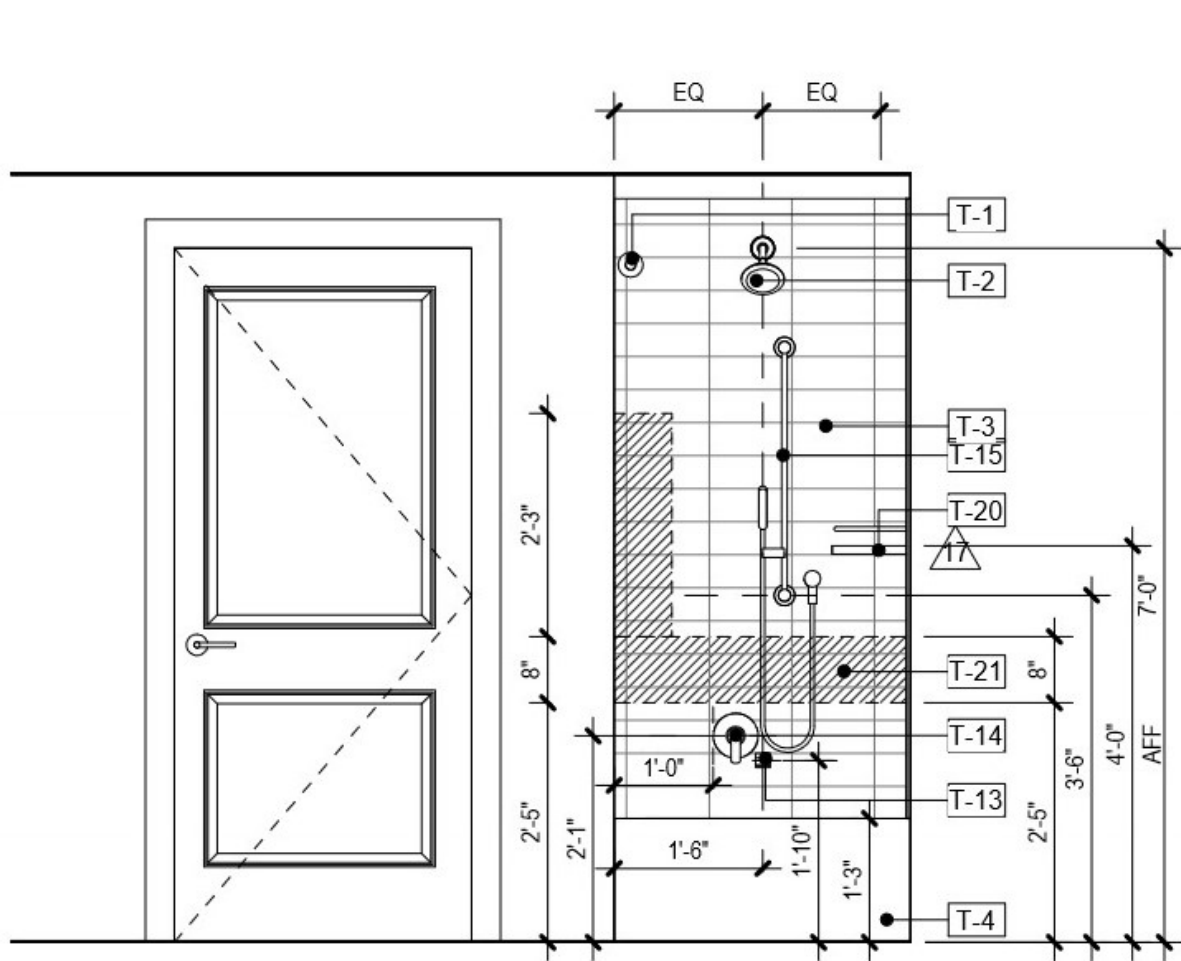

14  
A-423

# UNIT B3 - PRIMARY BATH - ELEV 3

Scale: 1/2" = 1'-0"



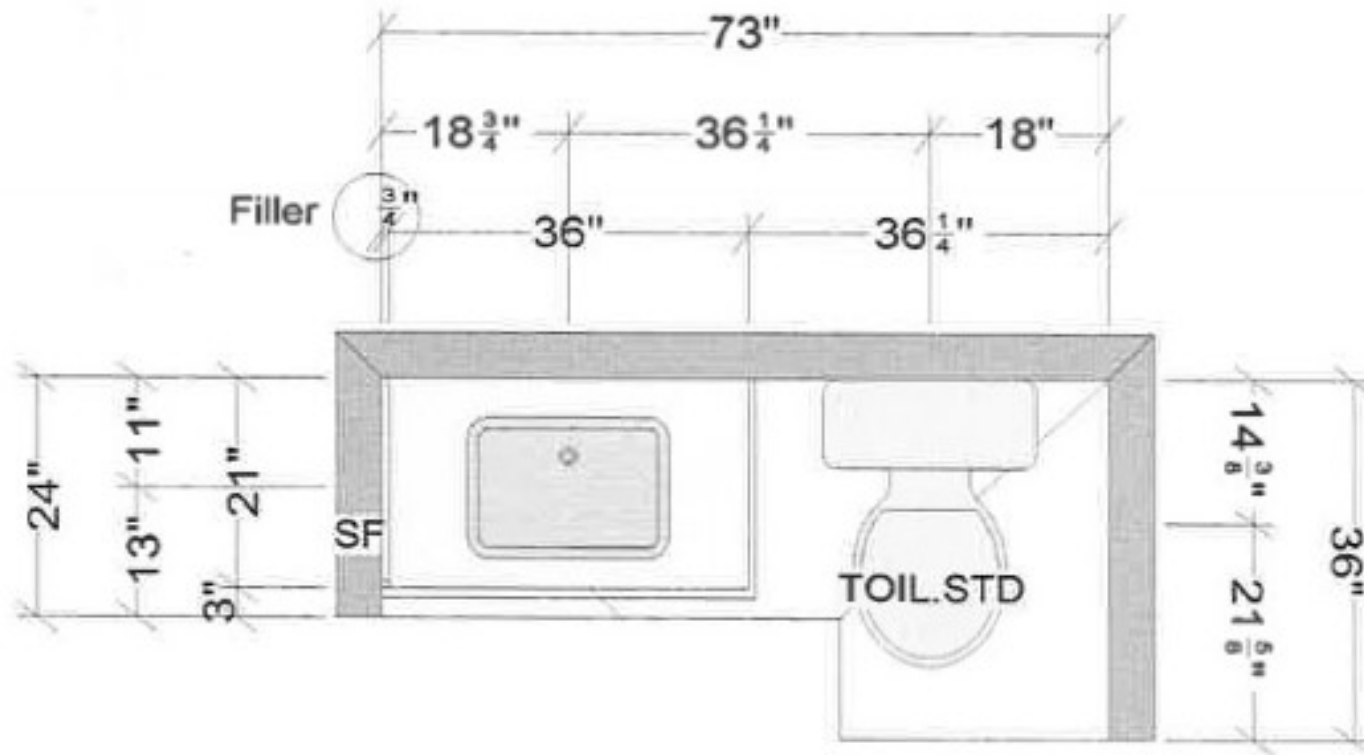

**Unit B3 Primary Bath**

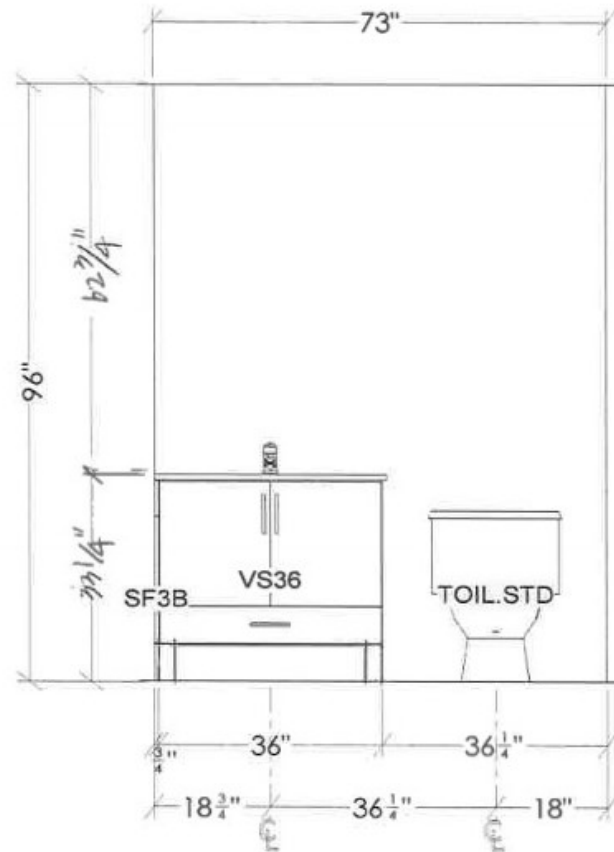

**UNIT B3 PRIMARY BATH**



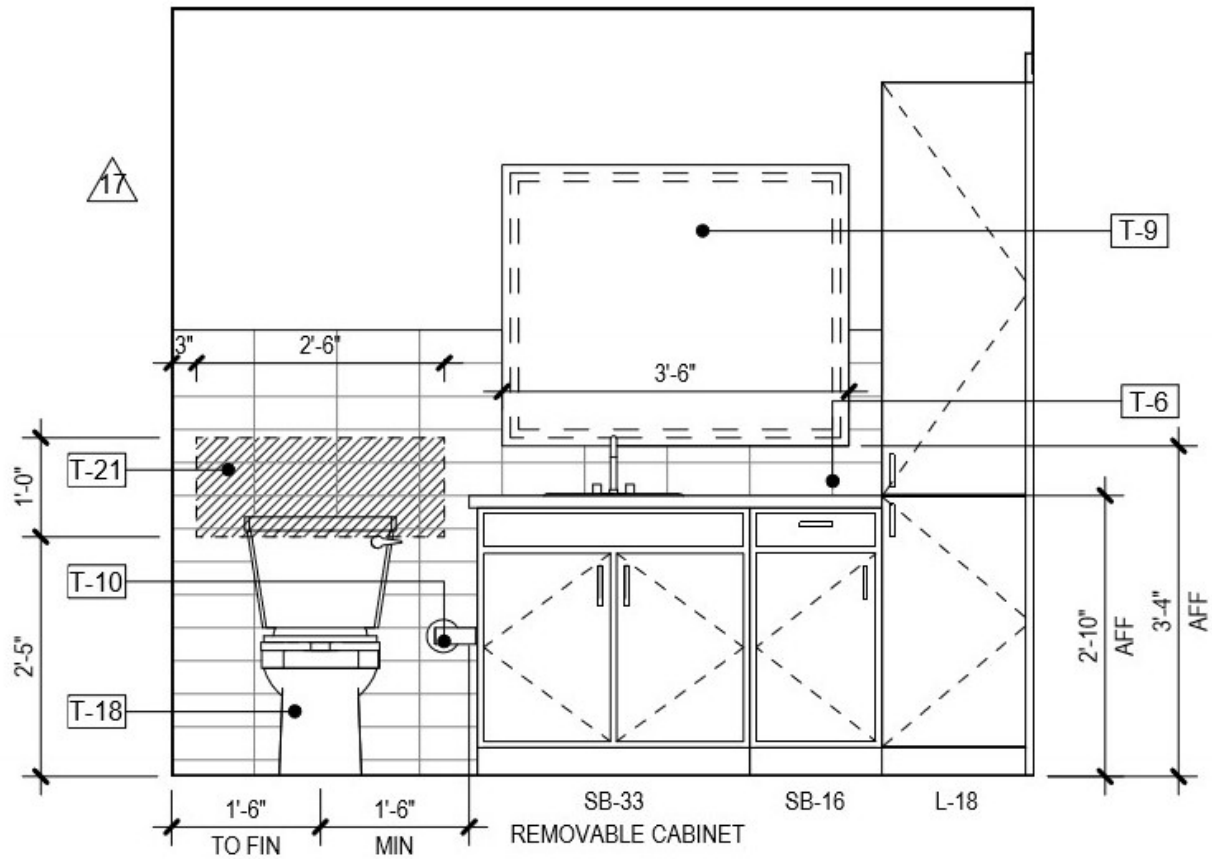

9  
A-423

# UNIT B3 - EN SUITE BATH - ELEV 1

Scale: 1/2" = 1'-0"

17

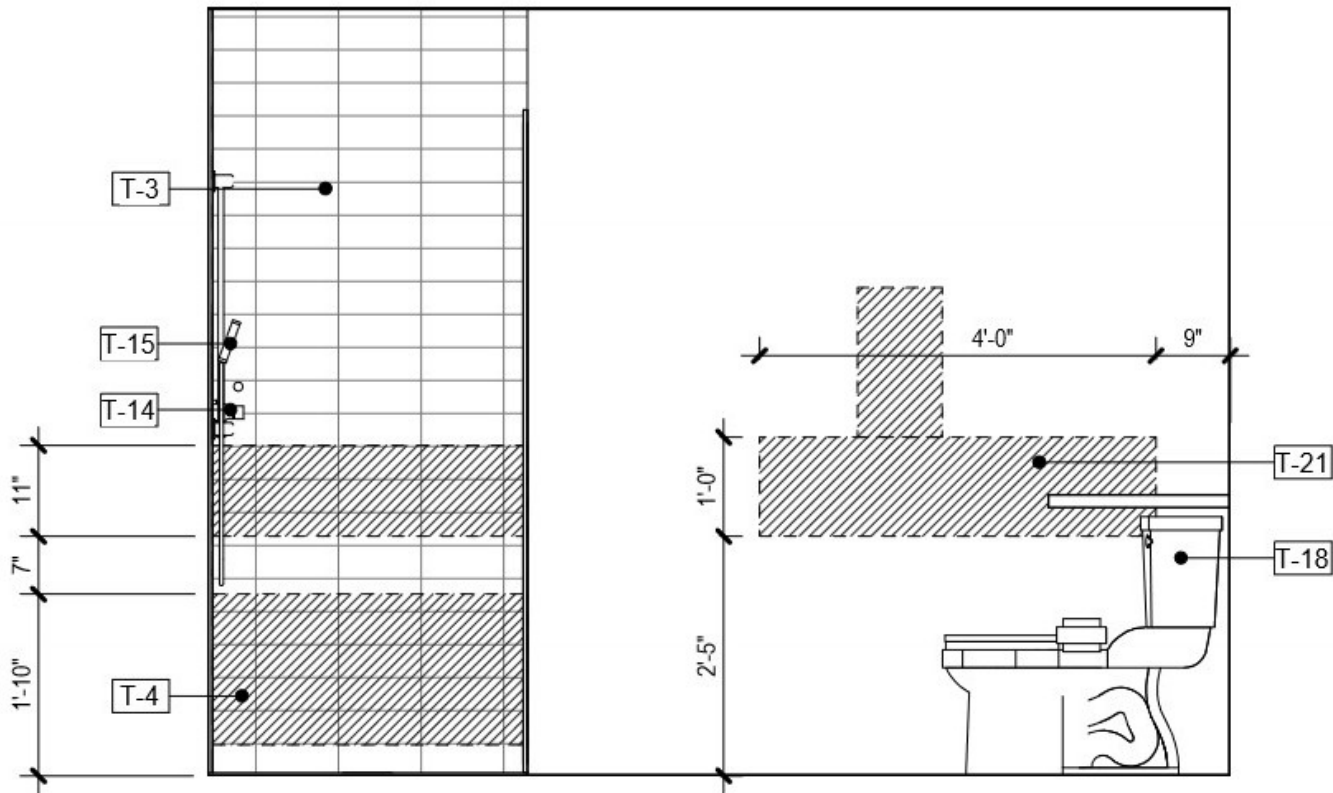

10  
A-423

# UNIT B3 - EN SUITE BATH - ELEV 2

Scale: 1/2" = 1'-0"

17

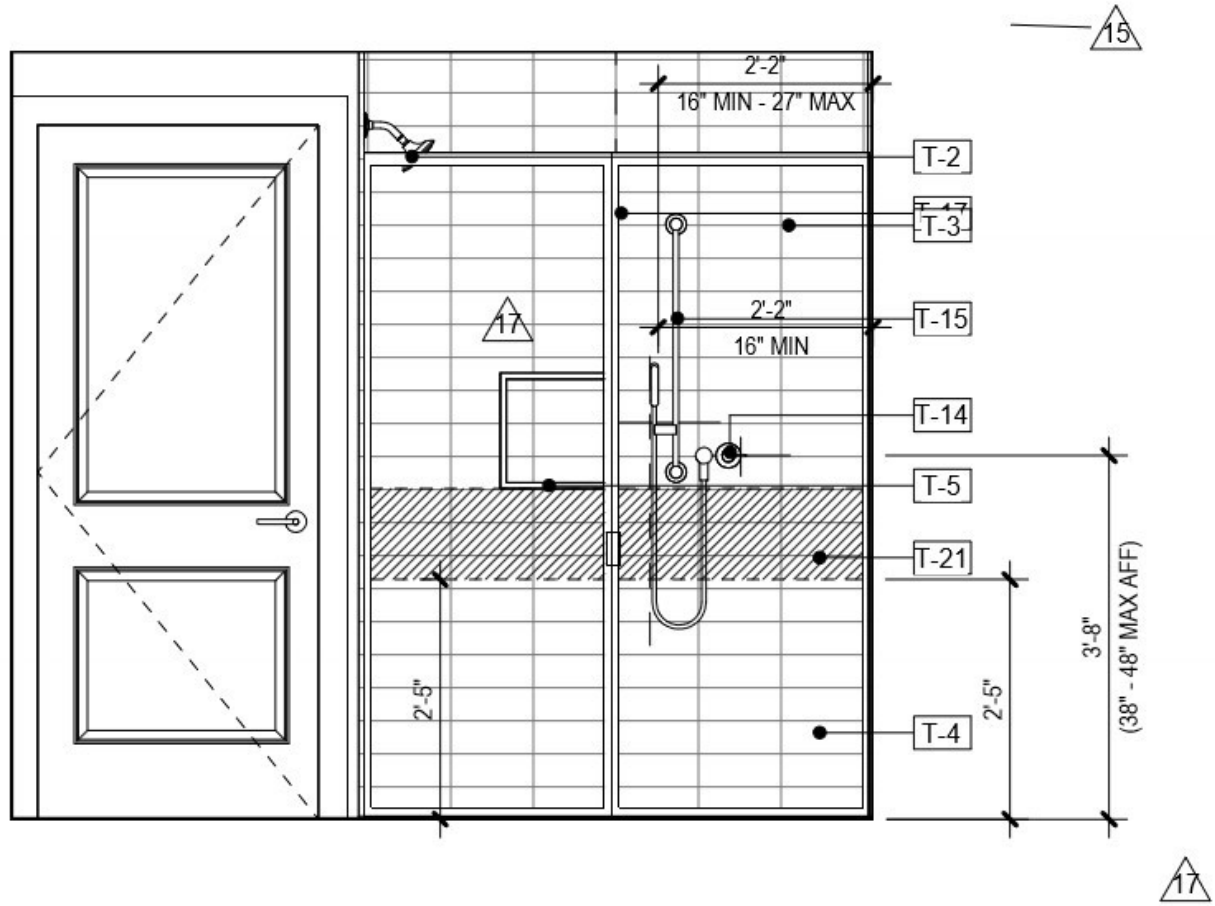

11  
A-423

# UNIT B3 - EN SUITE BATH - ELEV 3

Scale: 1/2" = 1'-0"

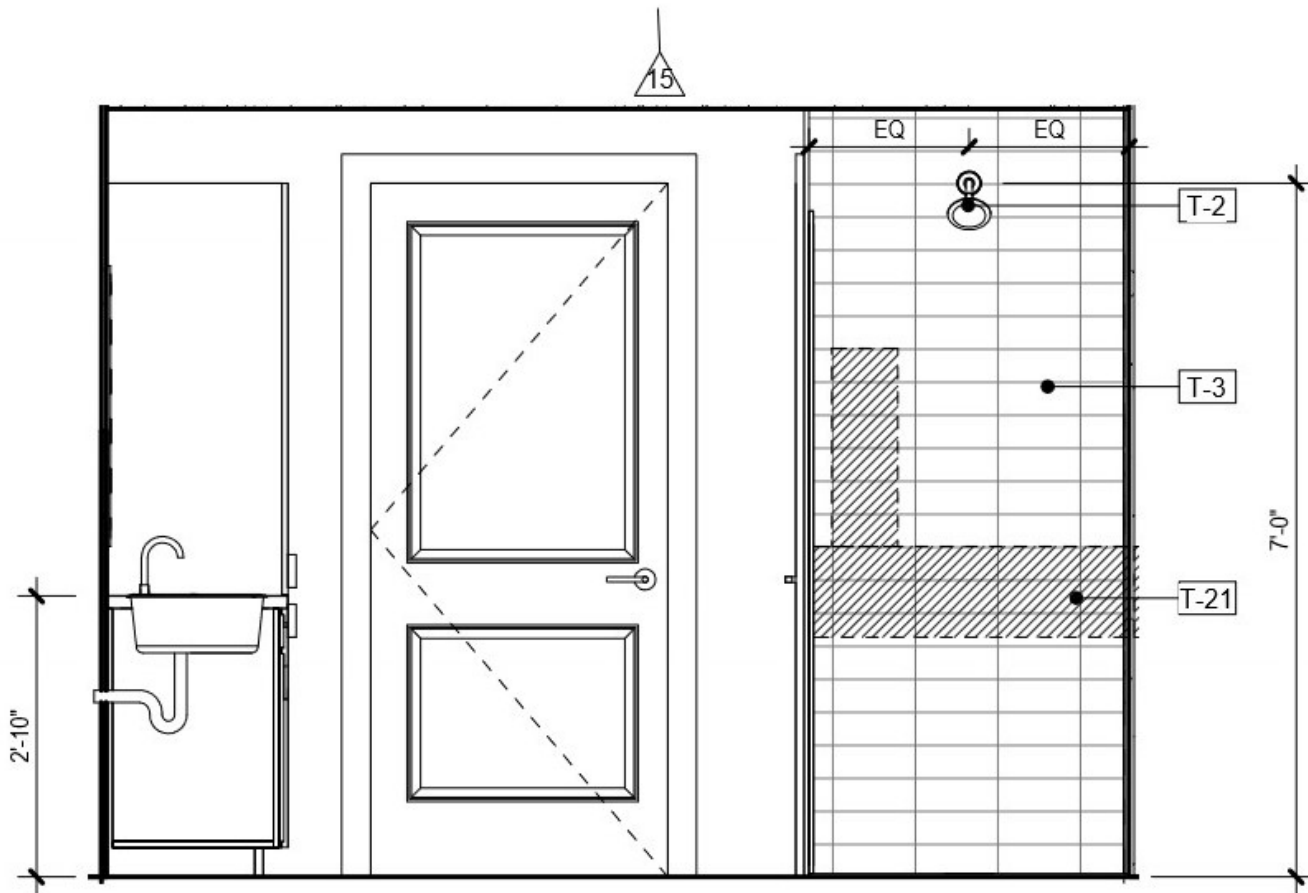

15  
A-423

# UNIT B3 - EN SUITE BATH - ELEV 4

Scale: 1/2" = 1'-0"

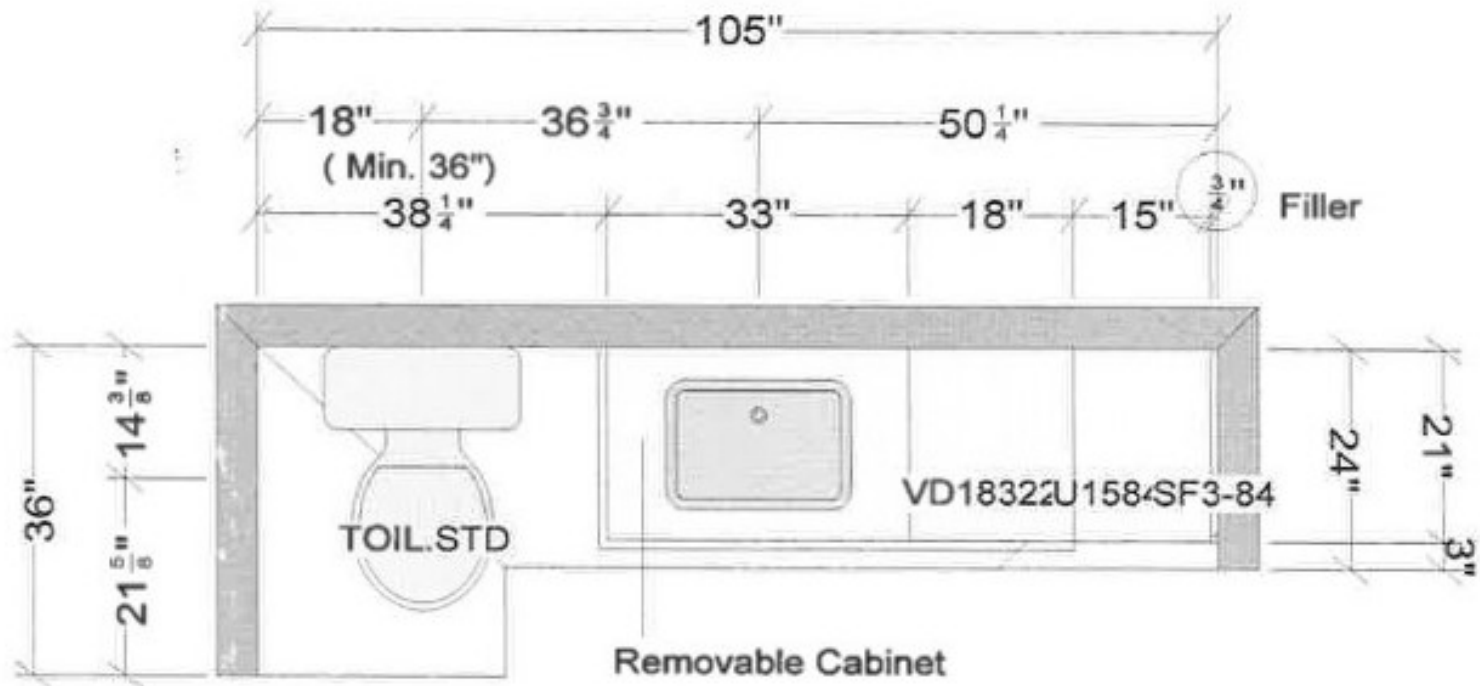

**Unit B3 EN Suite Bath**

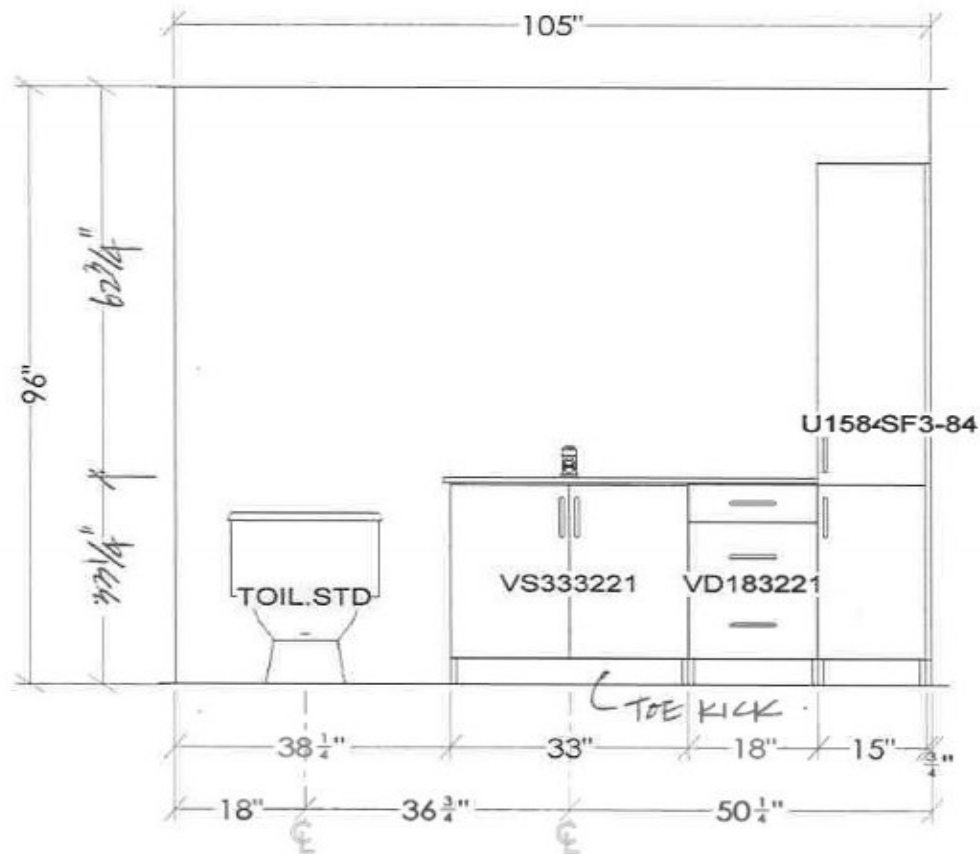

## UNIT B3 EN SUITE BATH

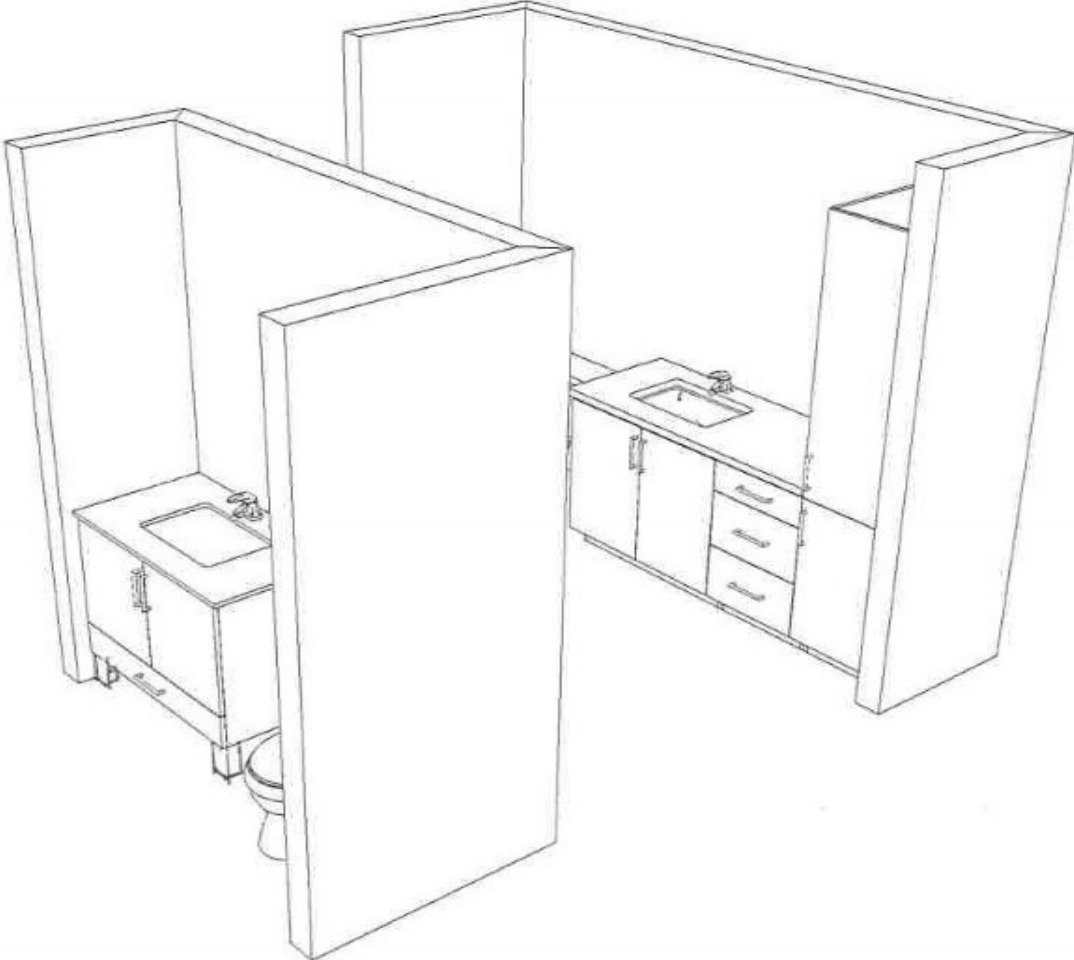

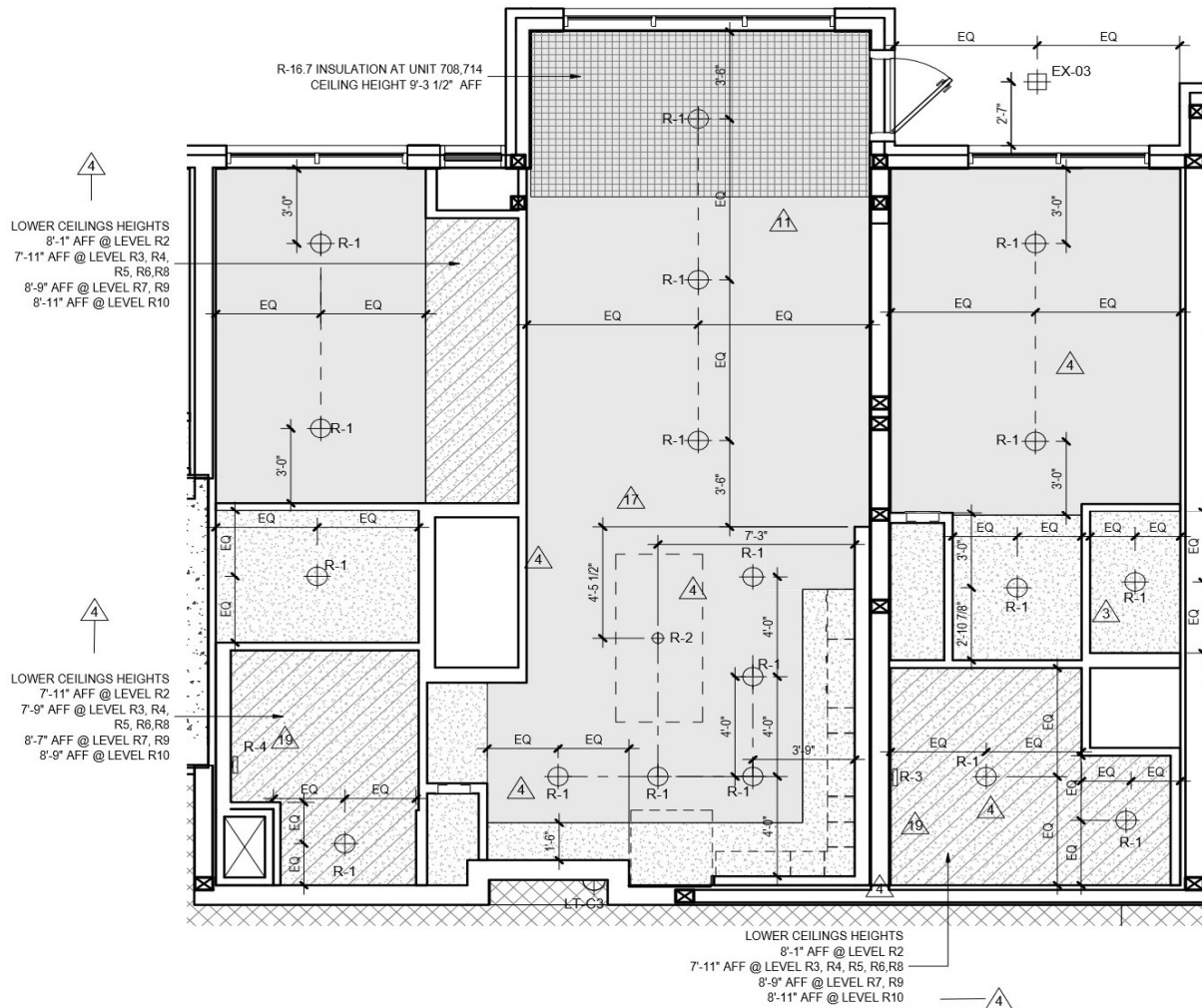

3 UNIT B3 RCP  
A-423 Scale: 1/4" = 1'-0"