

B3m1

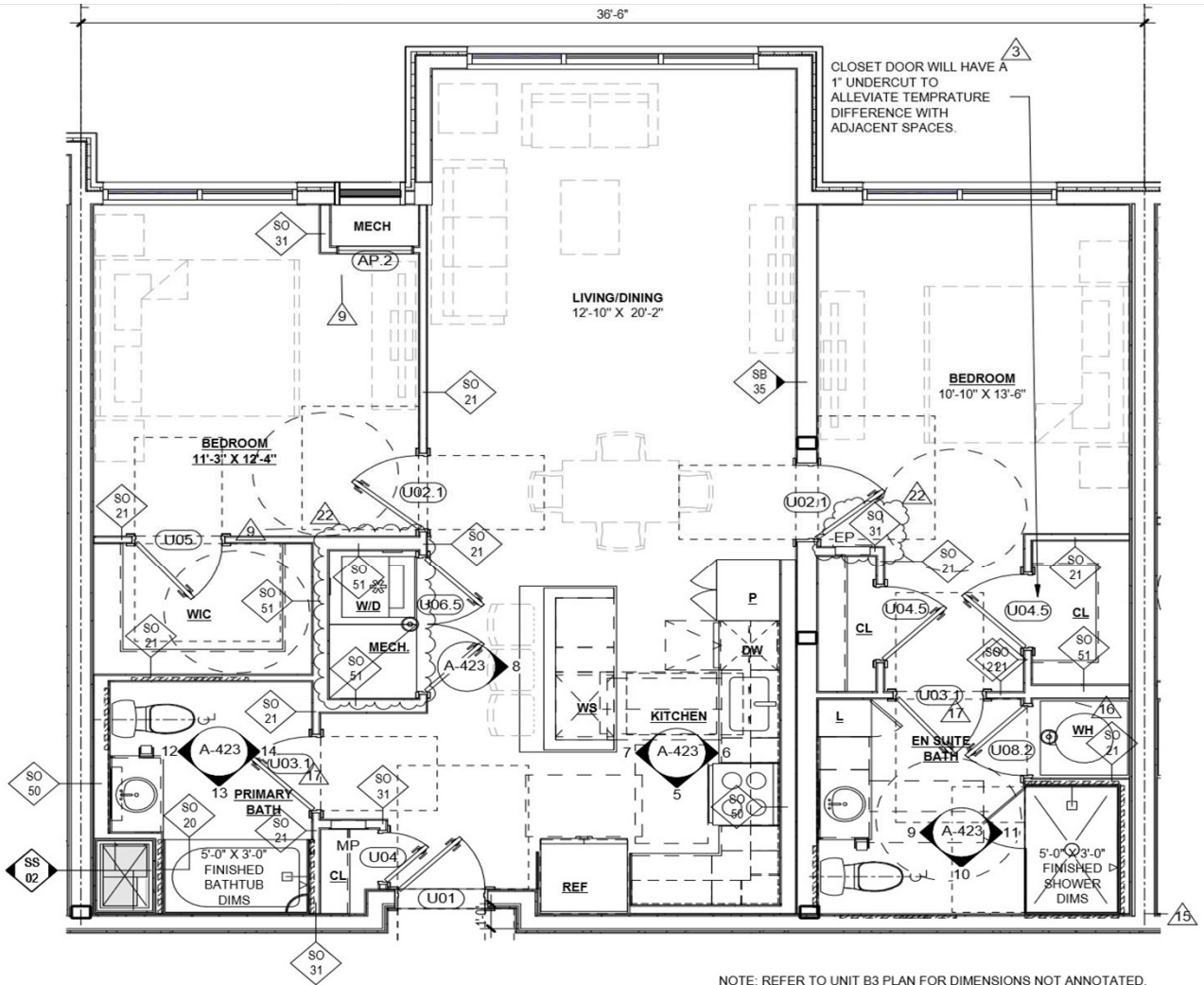

2
A-423

UNIT B3M1 PLAN

Scale: 1/4" = 1'-0"

TOTAL 3 UNIT

AREA

1160 GSF

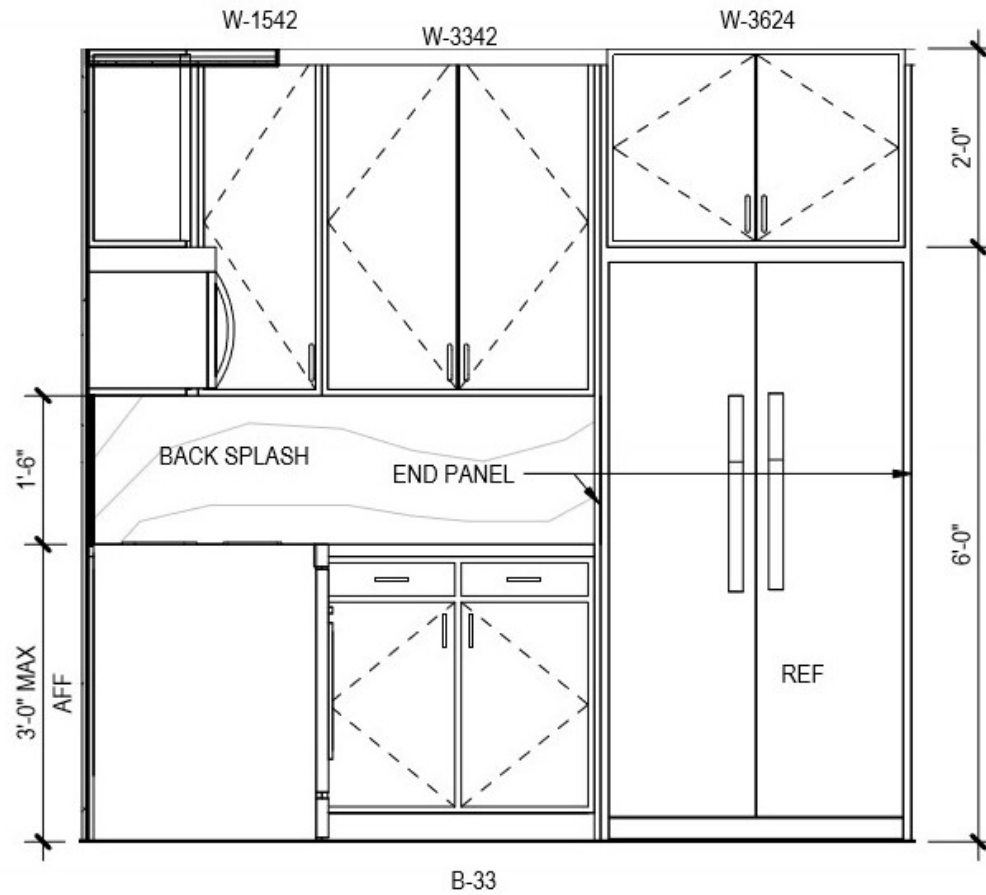

5
A-423

Scale: 1/2" = 1'-0"

- KITCHEN - ELEV 1

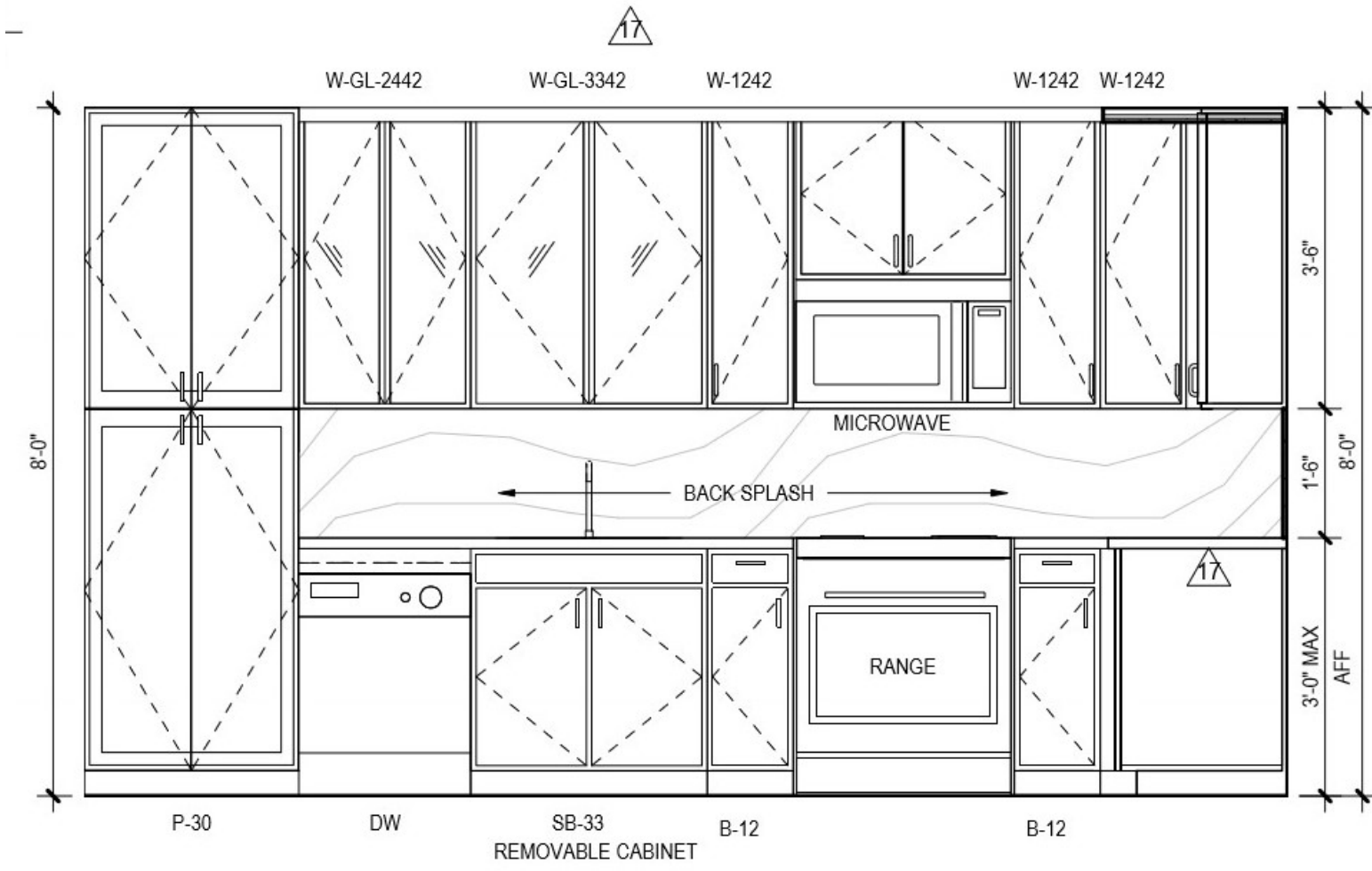

6
A-423

Scale: 1/2" = 1'-0"

- KITCHEN - ELEV 2

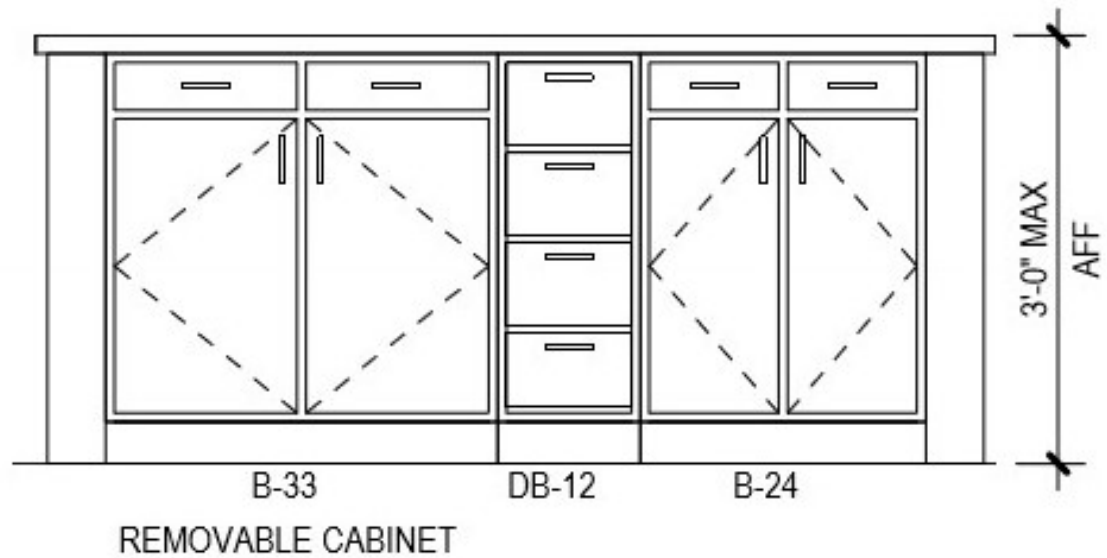

7
A-423

- KITCHEN - ELEV 3

Scale: 1/2" = 1'-0"



8
A-423

UNIT B3 - KITCHEN - ELEV 4

Scale: 1/2" = 1'-0"

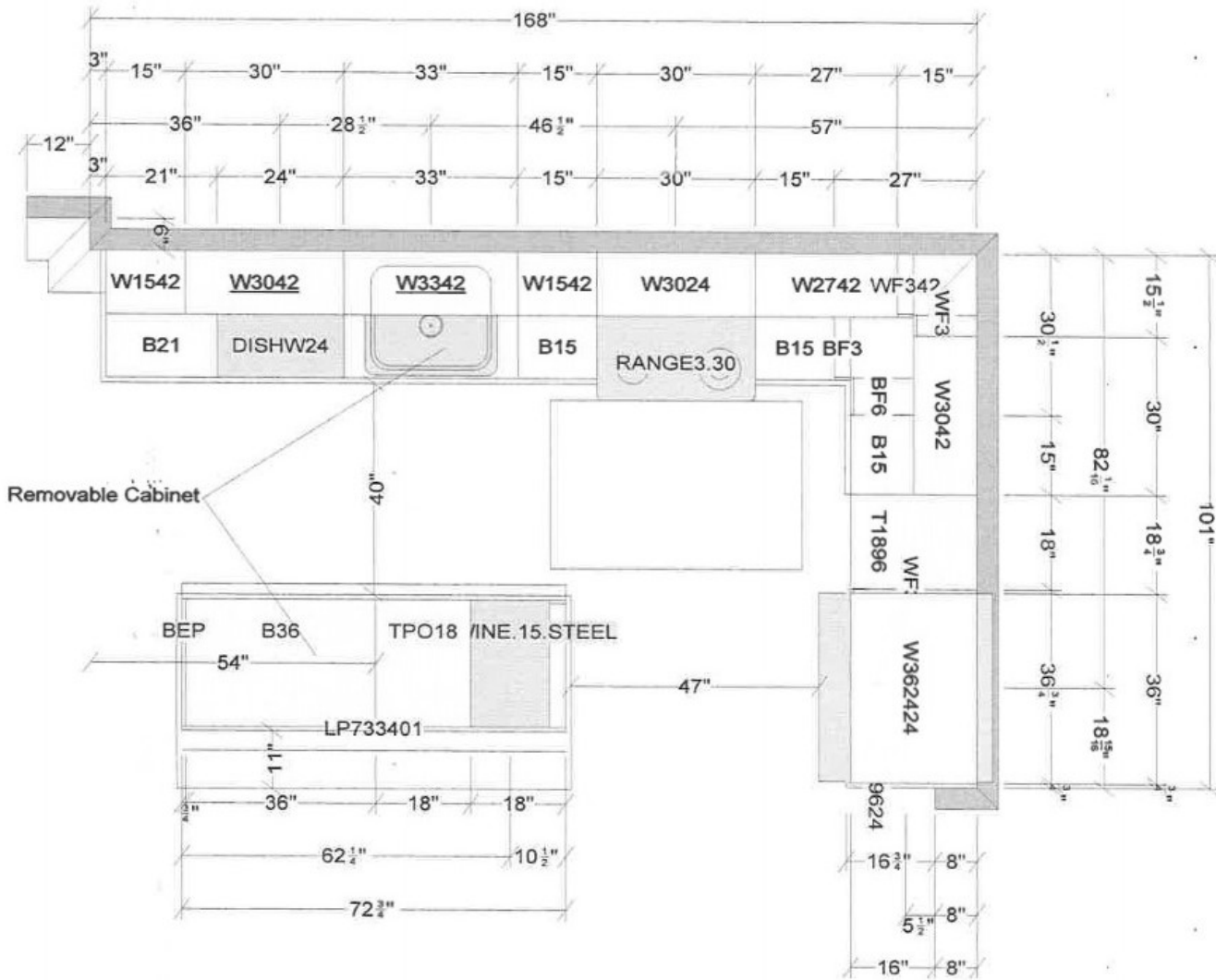

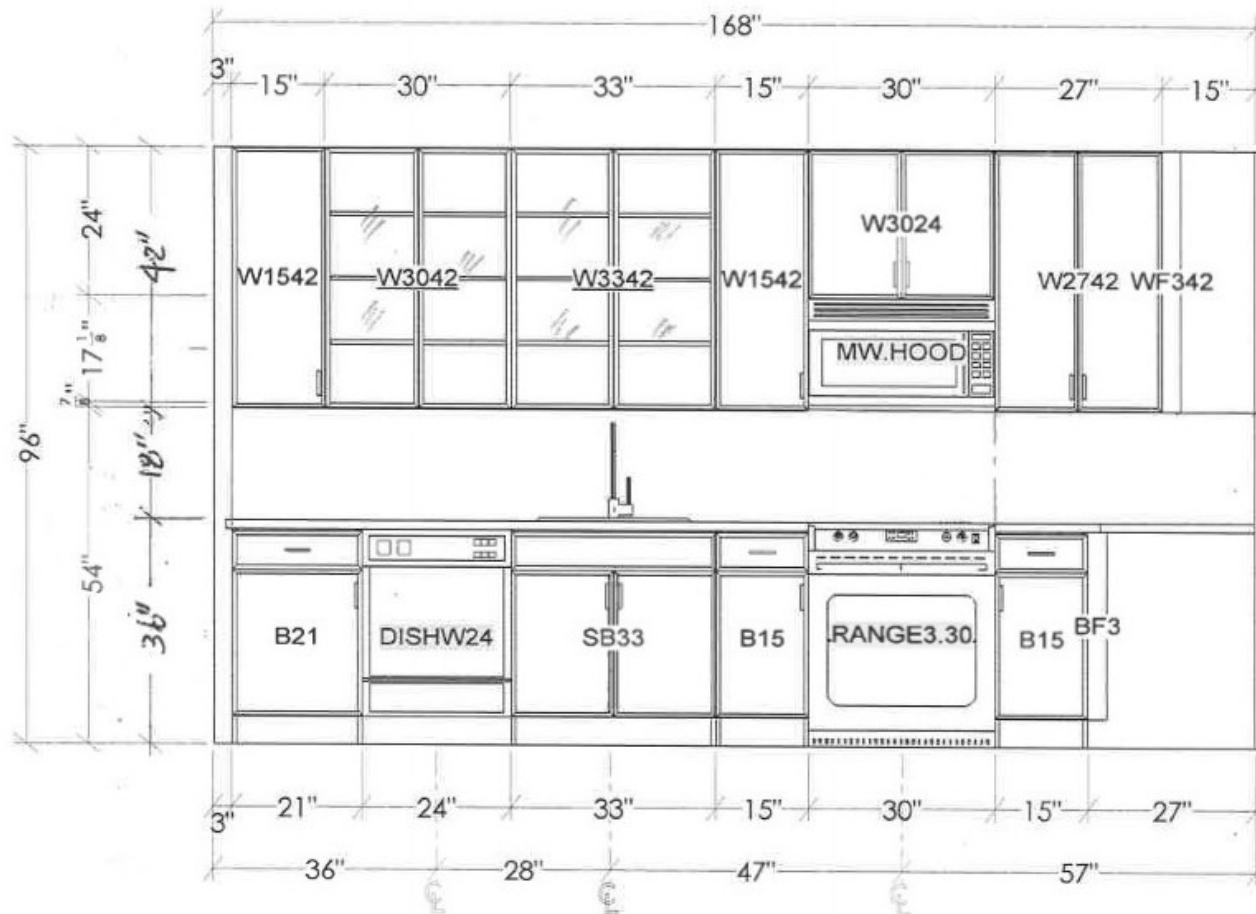

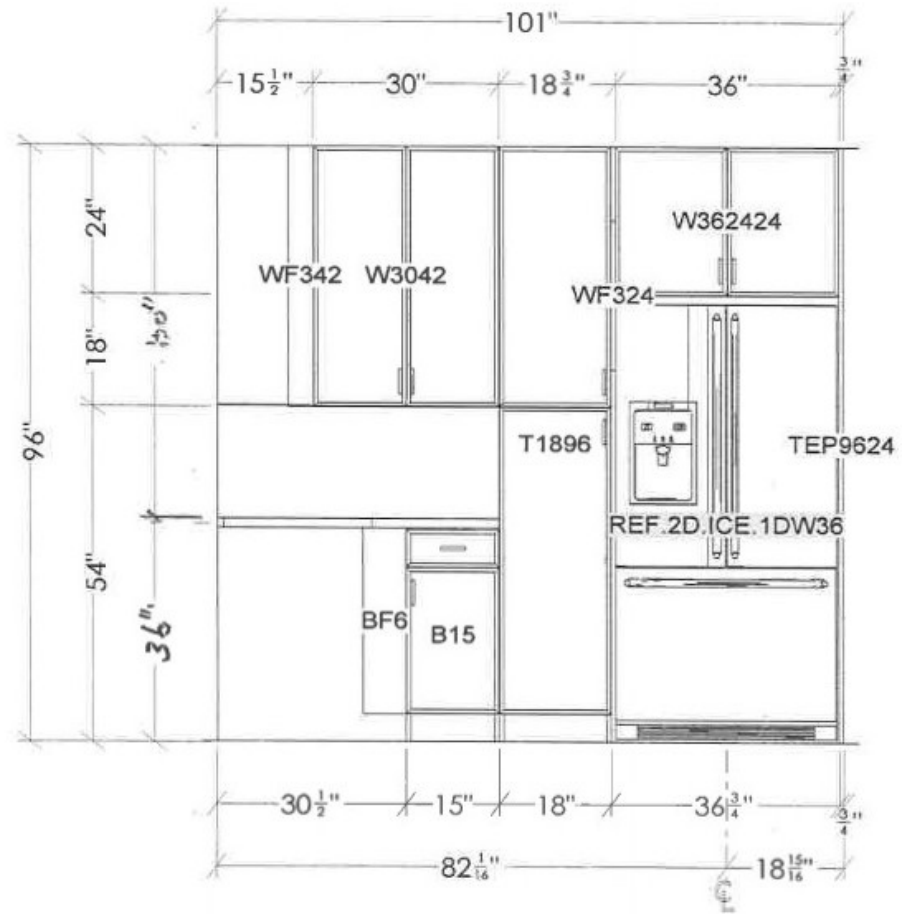

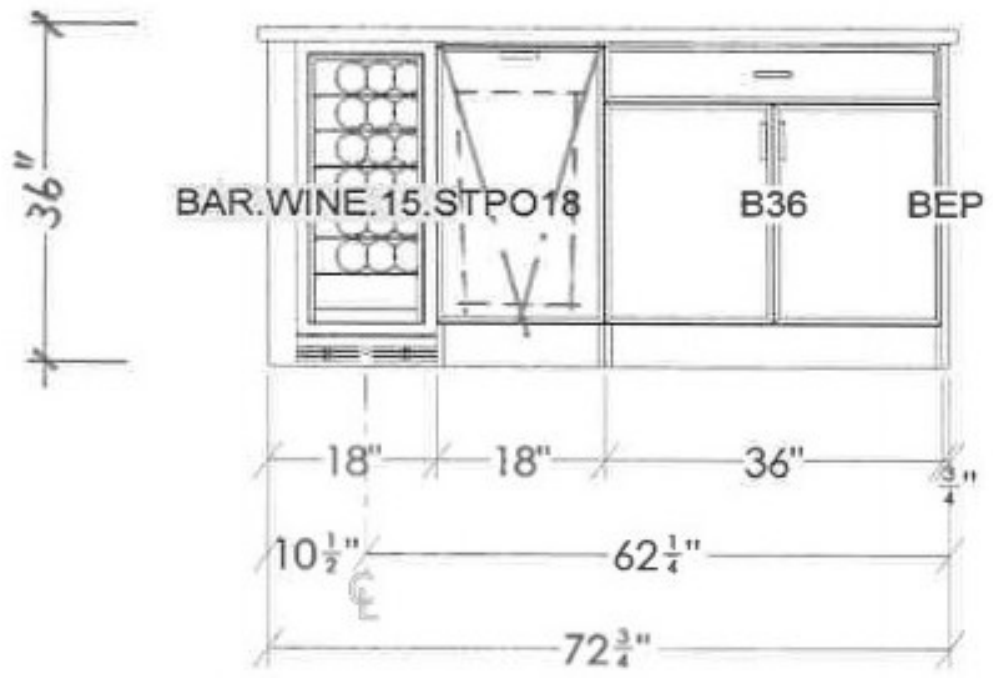



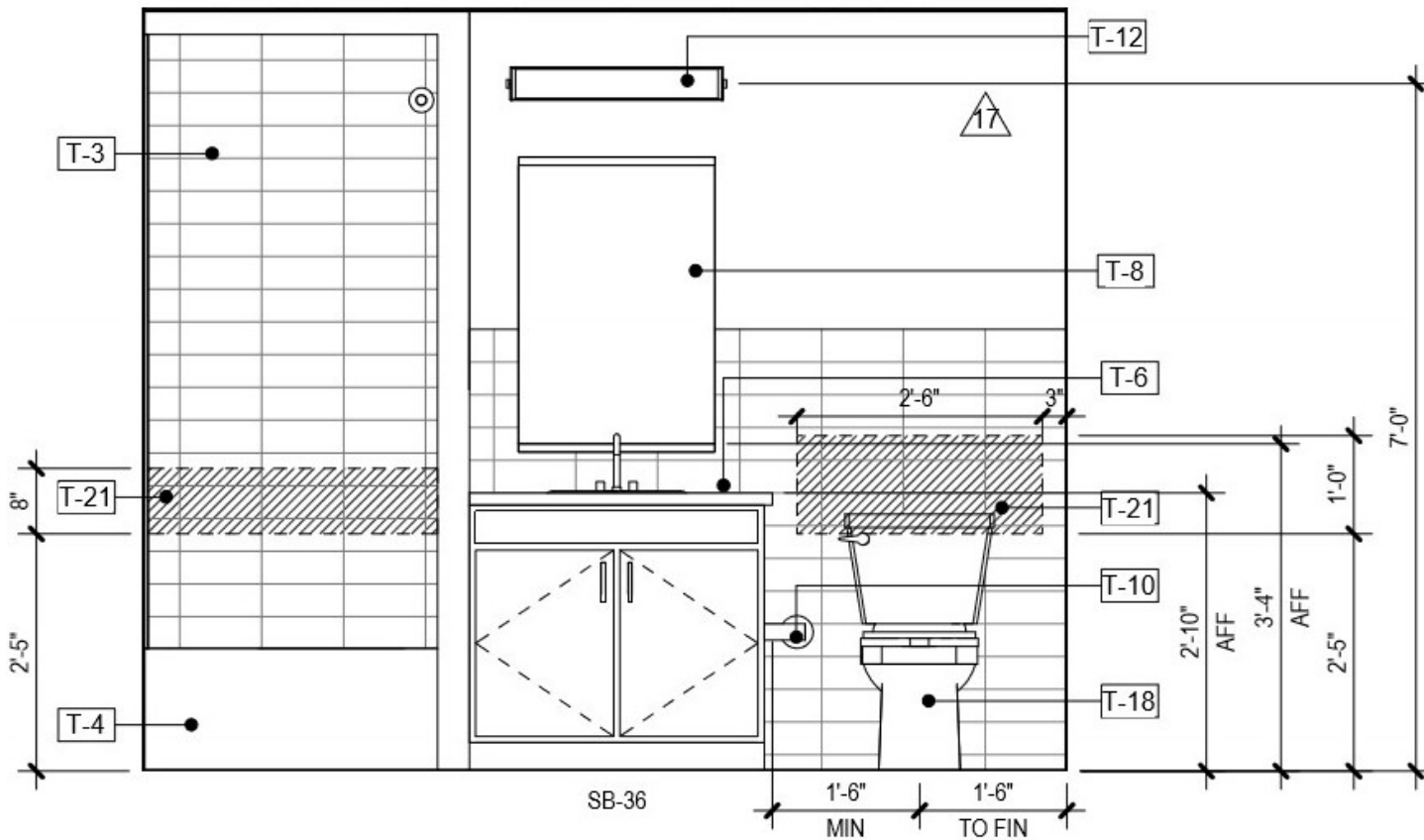

12
A-423

Scale: 1/2" = 1'-0"

- PRIMARY BATH - ELEV 1

17

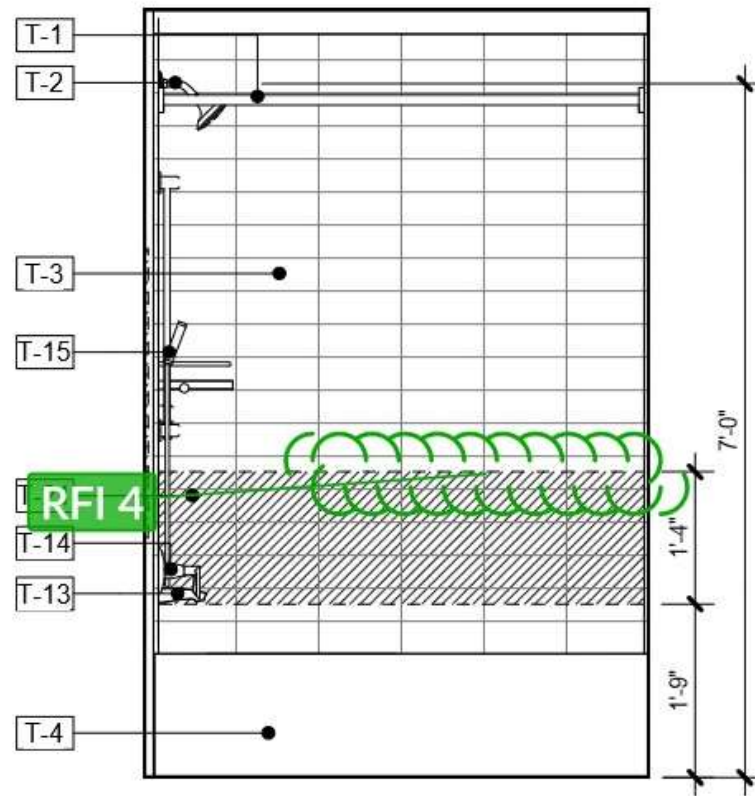

13
A-423

UNIT B3 - PRIMARY BATH - ELEV 2

Scale: 1/2" = 1'-0"

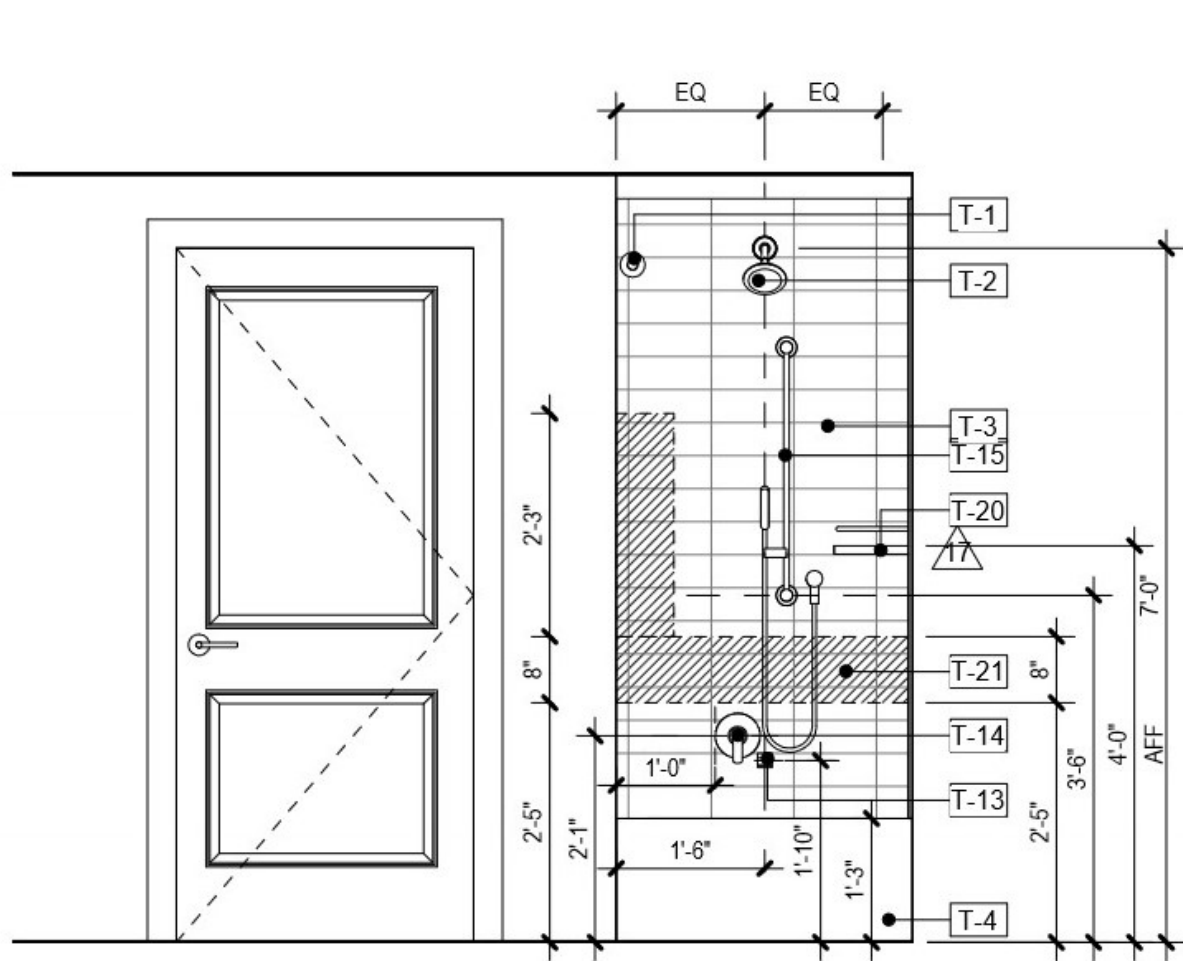

14
A-423

Scale: 1/2" = 1'-0"

- PRIMARY BATH - ELEV 3



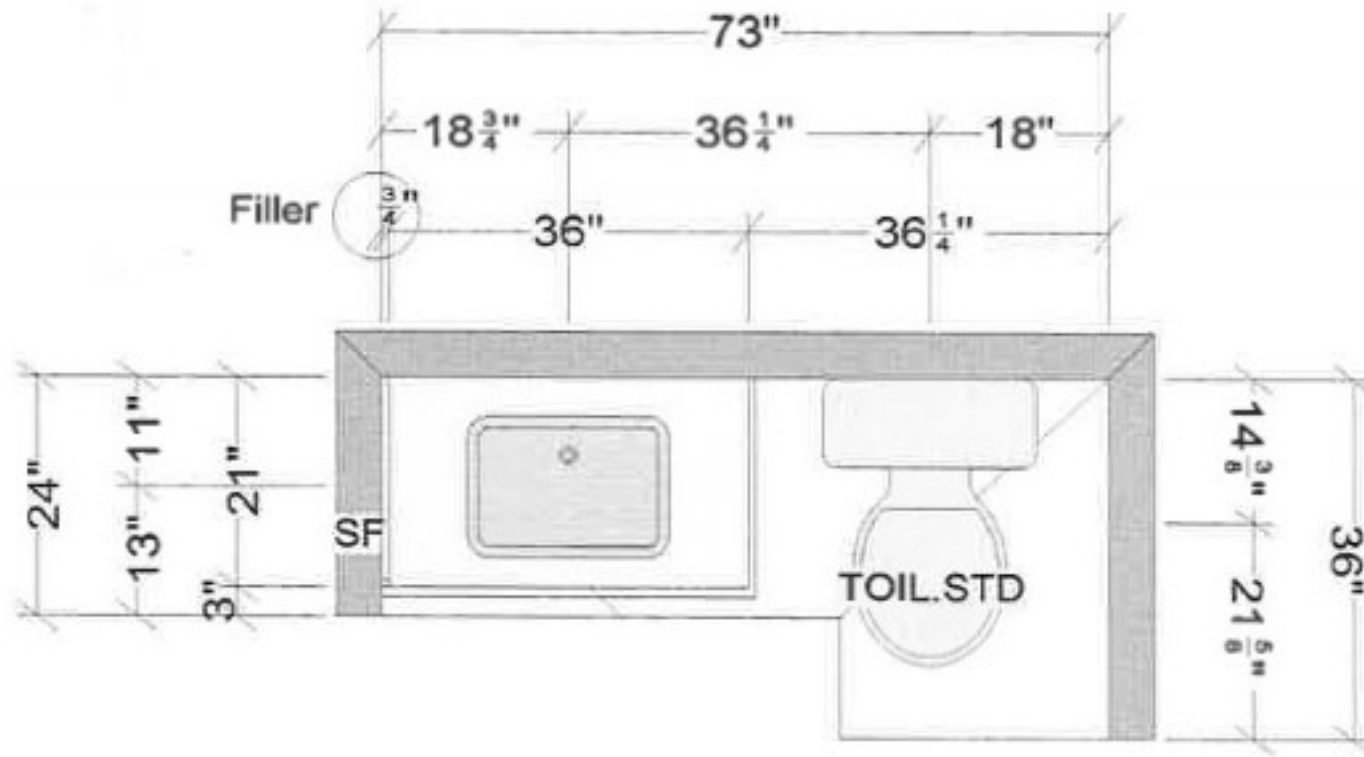

Primary Bath

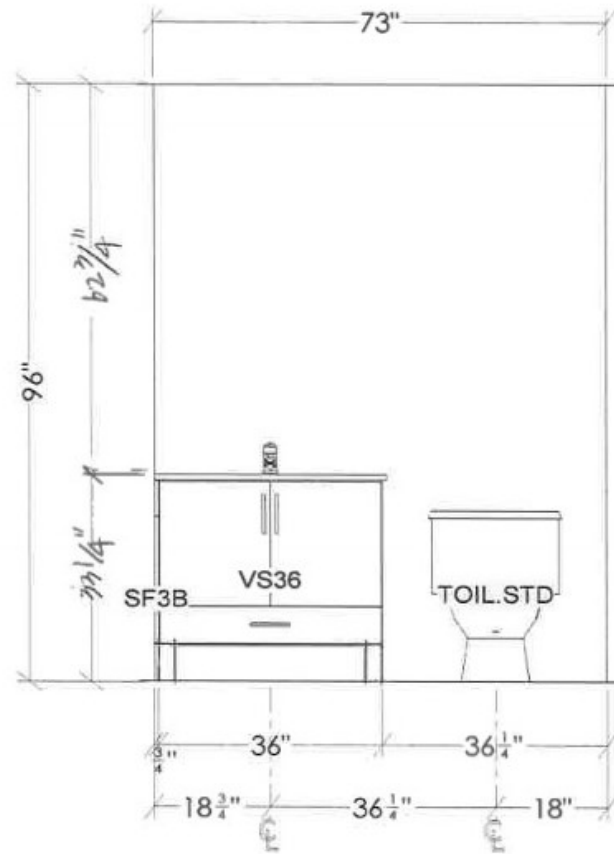

PRIMARY BATH

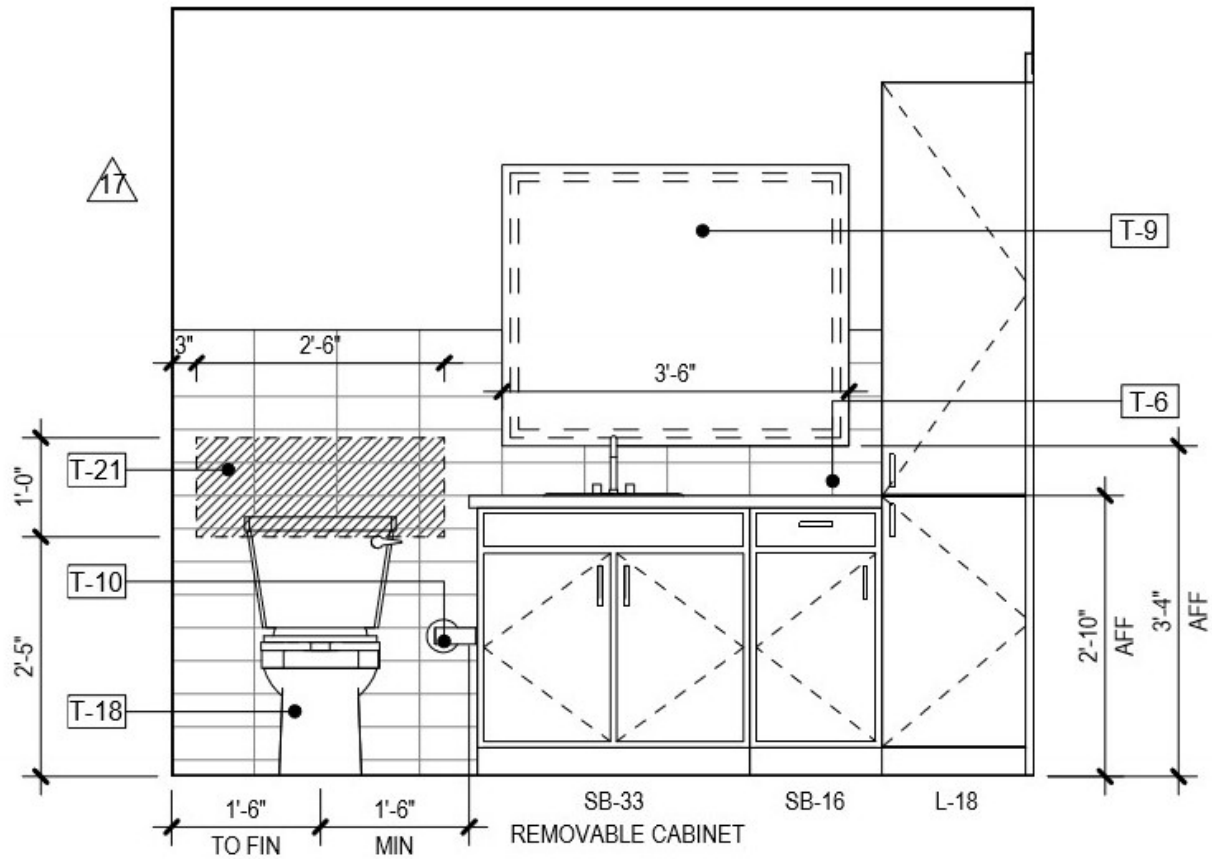

9
A-423

Scale: 1/2" = 1'-0"

- EN SUITE BATH - ELEV 1

17

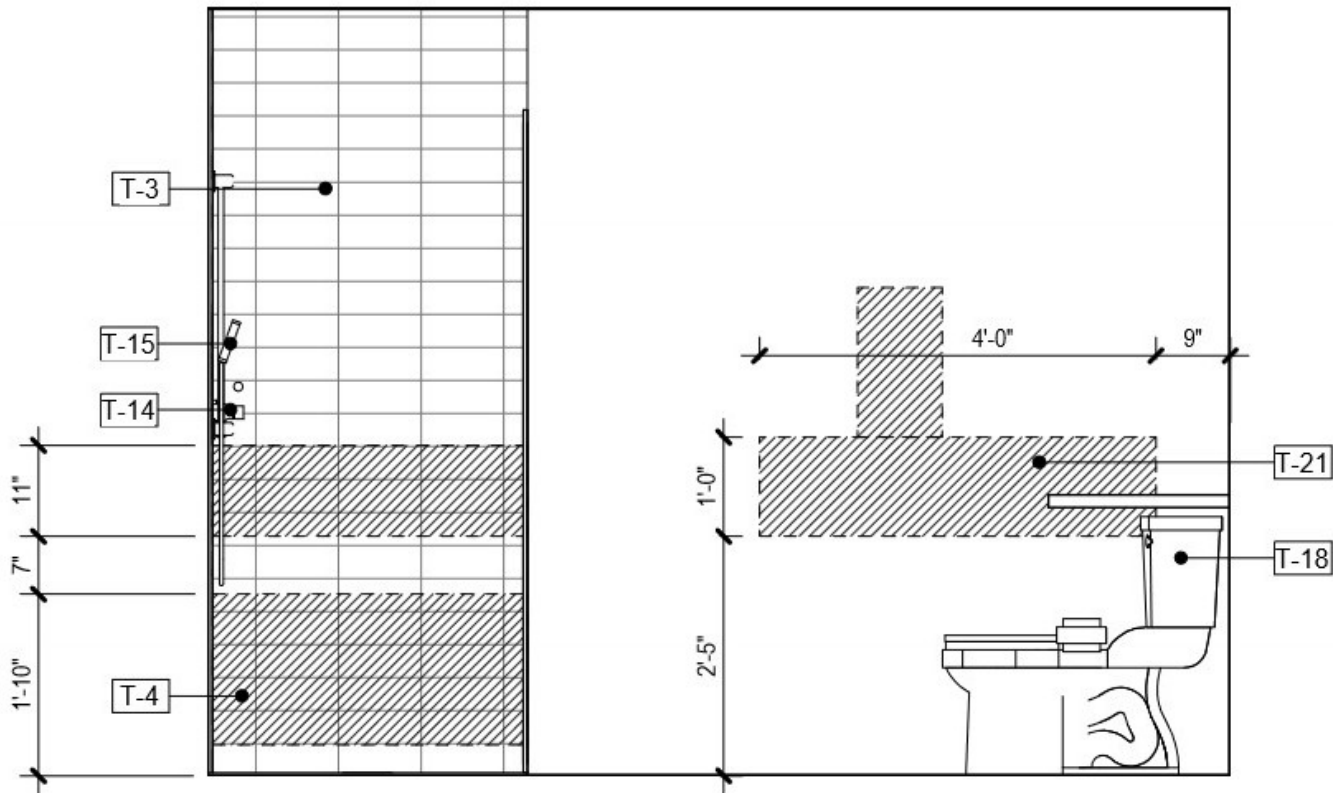

10
A-423

Scale: 1/2" = 1'-0"

- EN SUITE BATH - ELEV 2

17

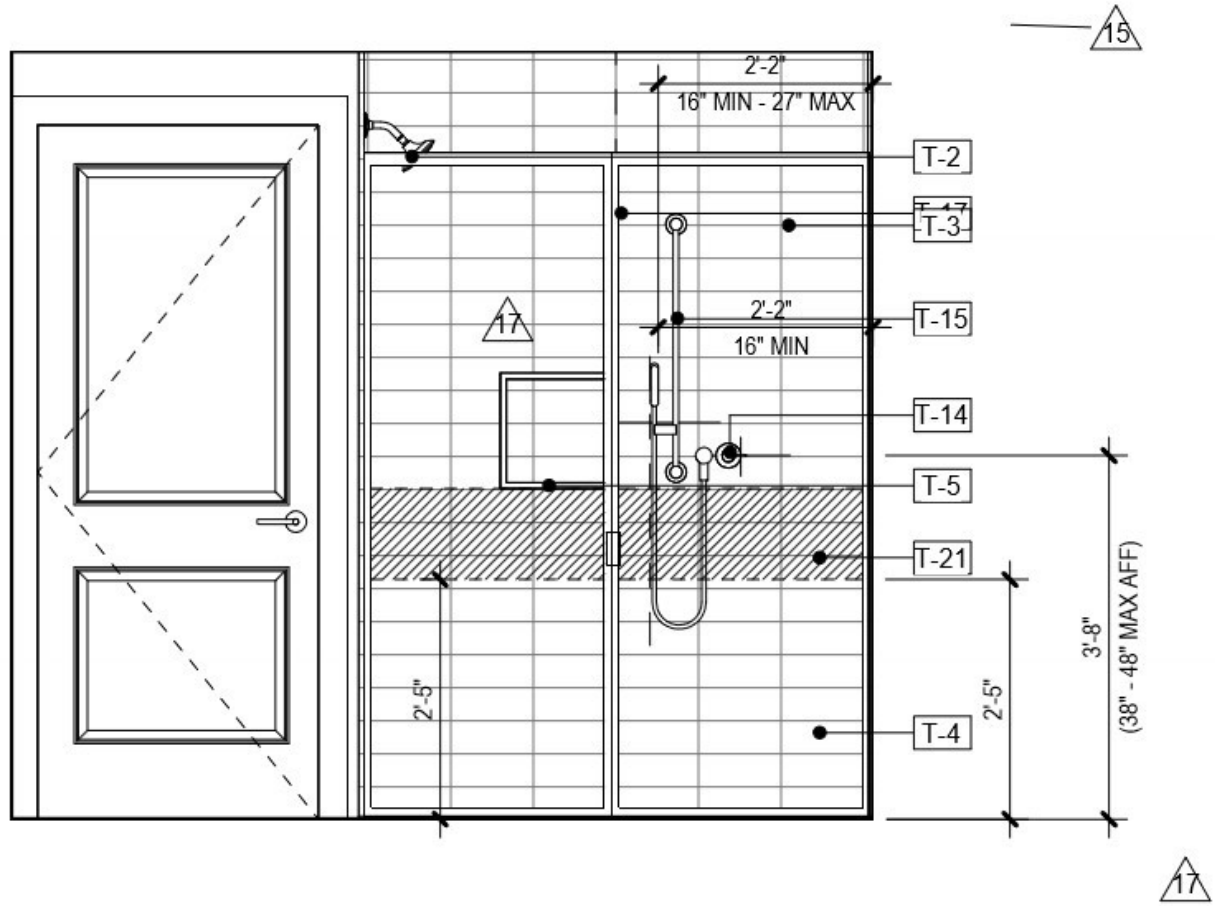

11
A-423

Scale: 1/2" = 1'-0"

- EN SUITE BATH - ELEV 3

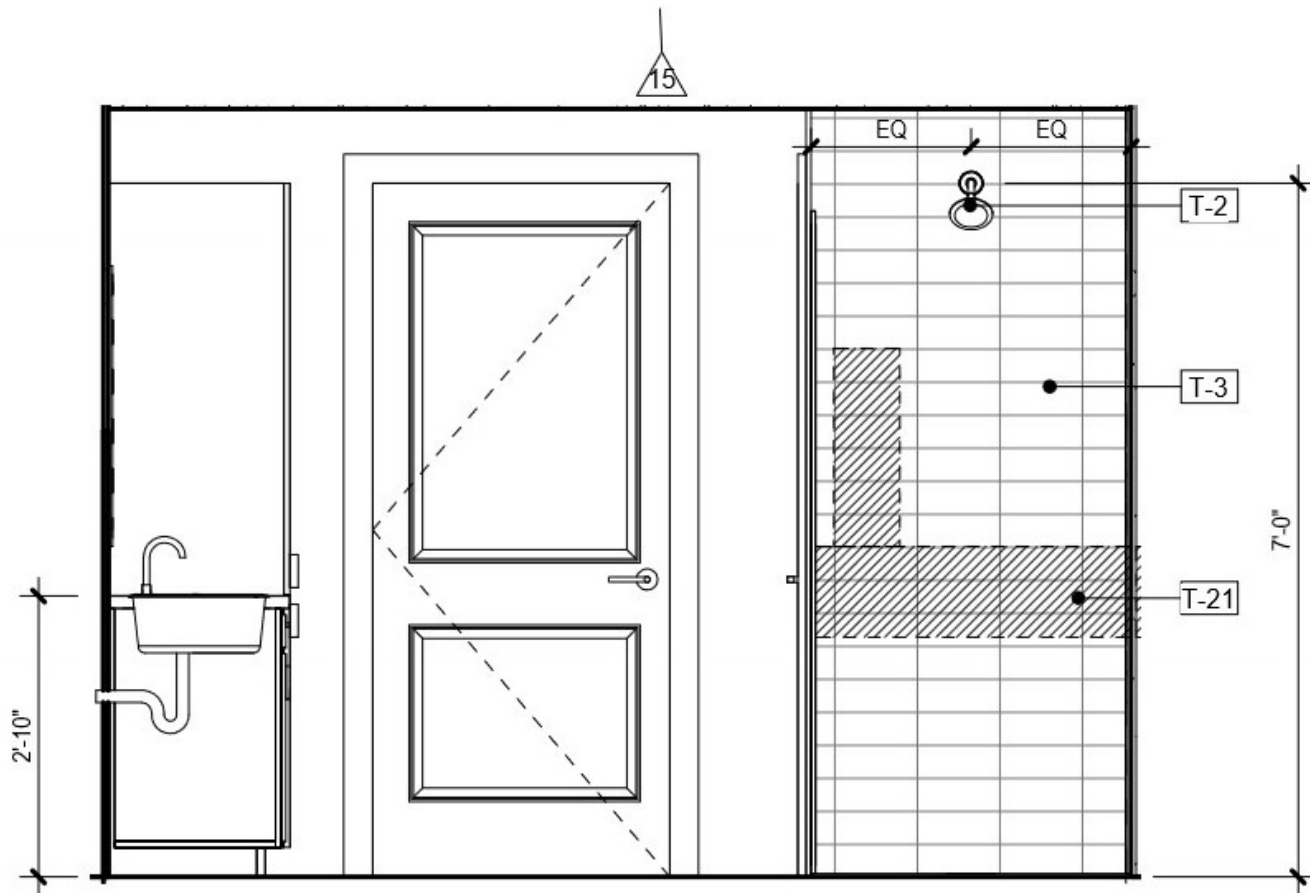

15
A-423

Scale: 1/2" = 1'-0"

- EN SUITE BATH - ELEV 4

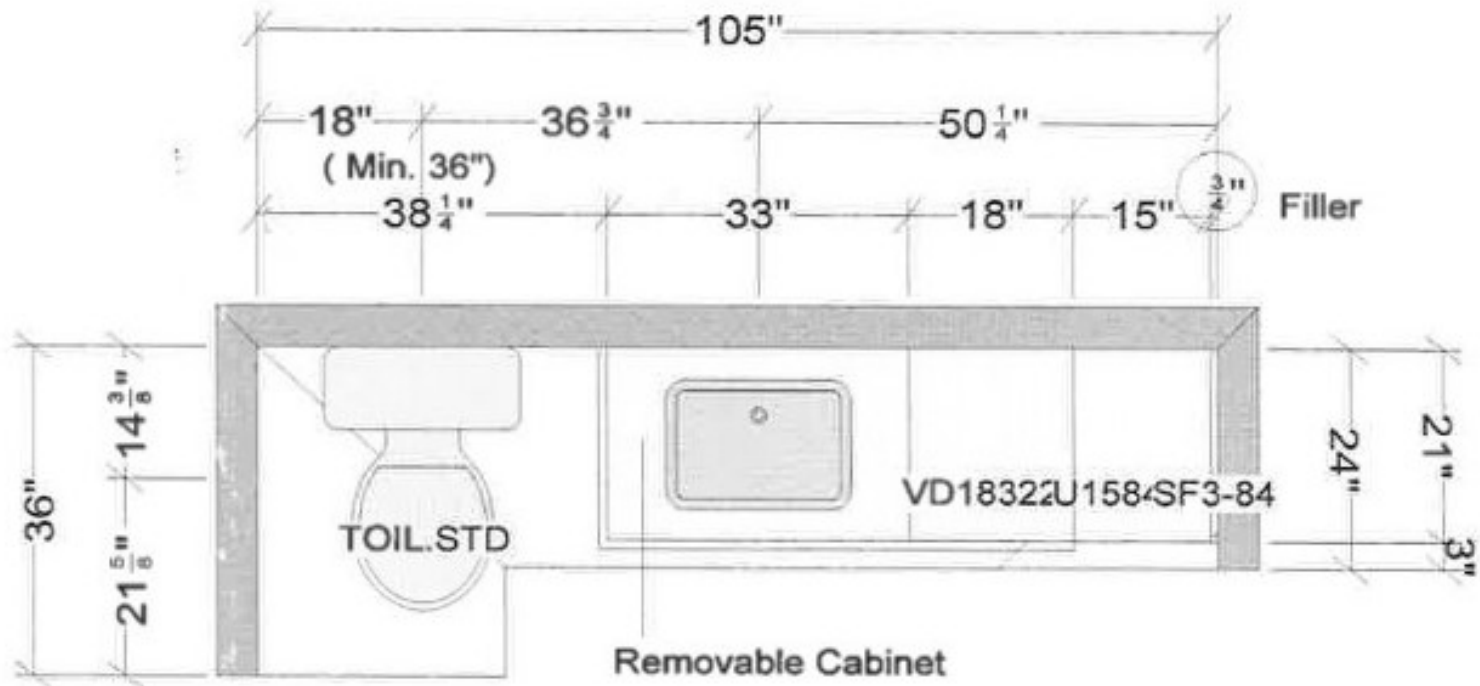

EN Suite Bath

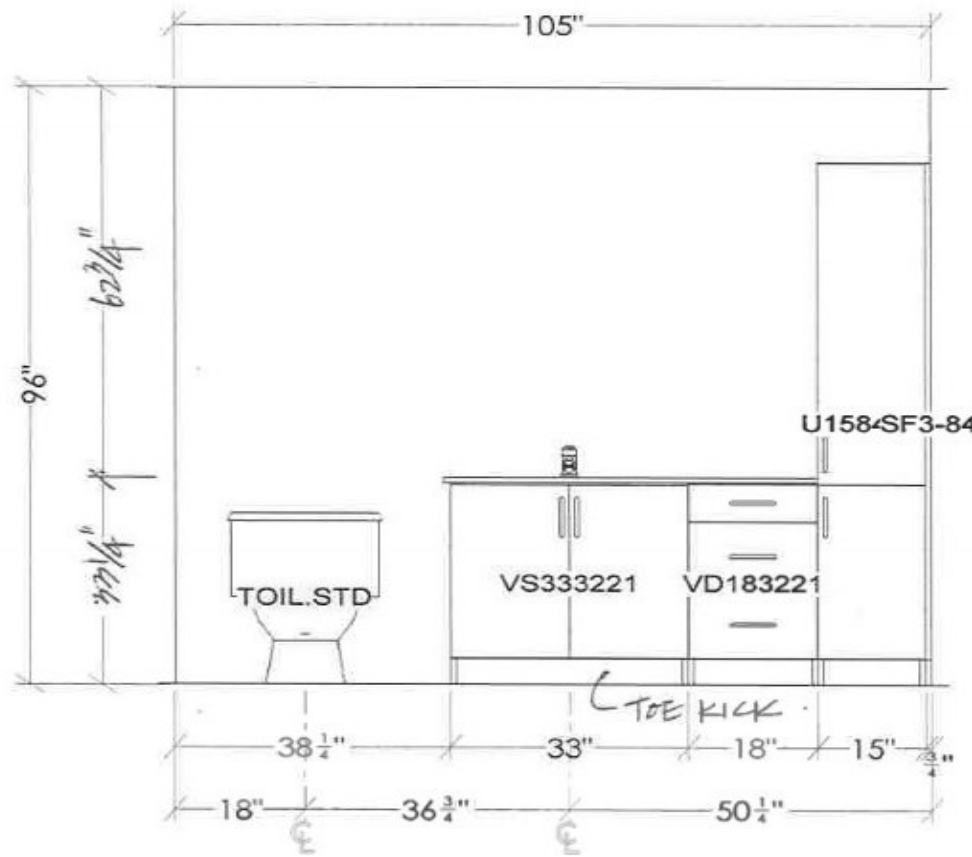

EN SUITE BATH

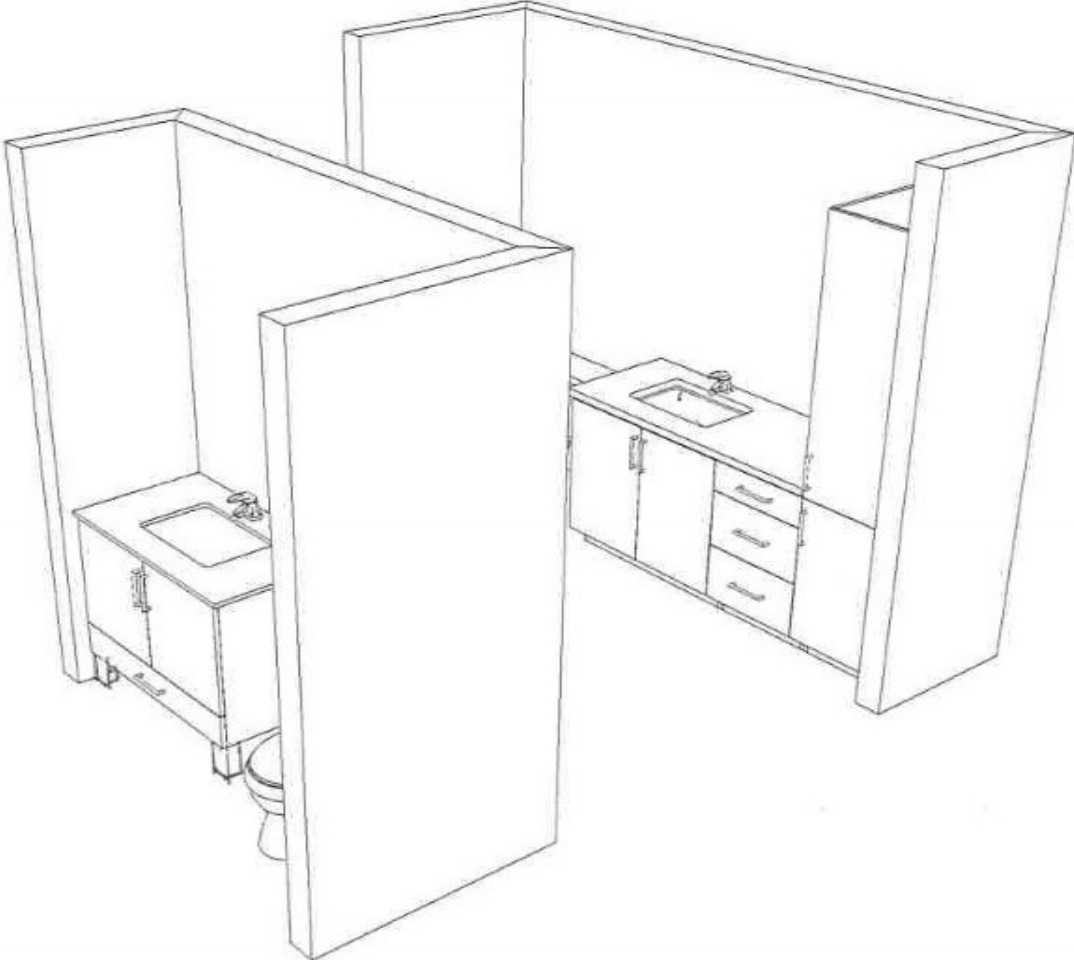

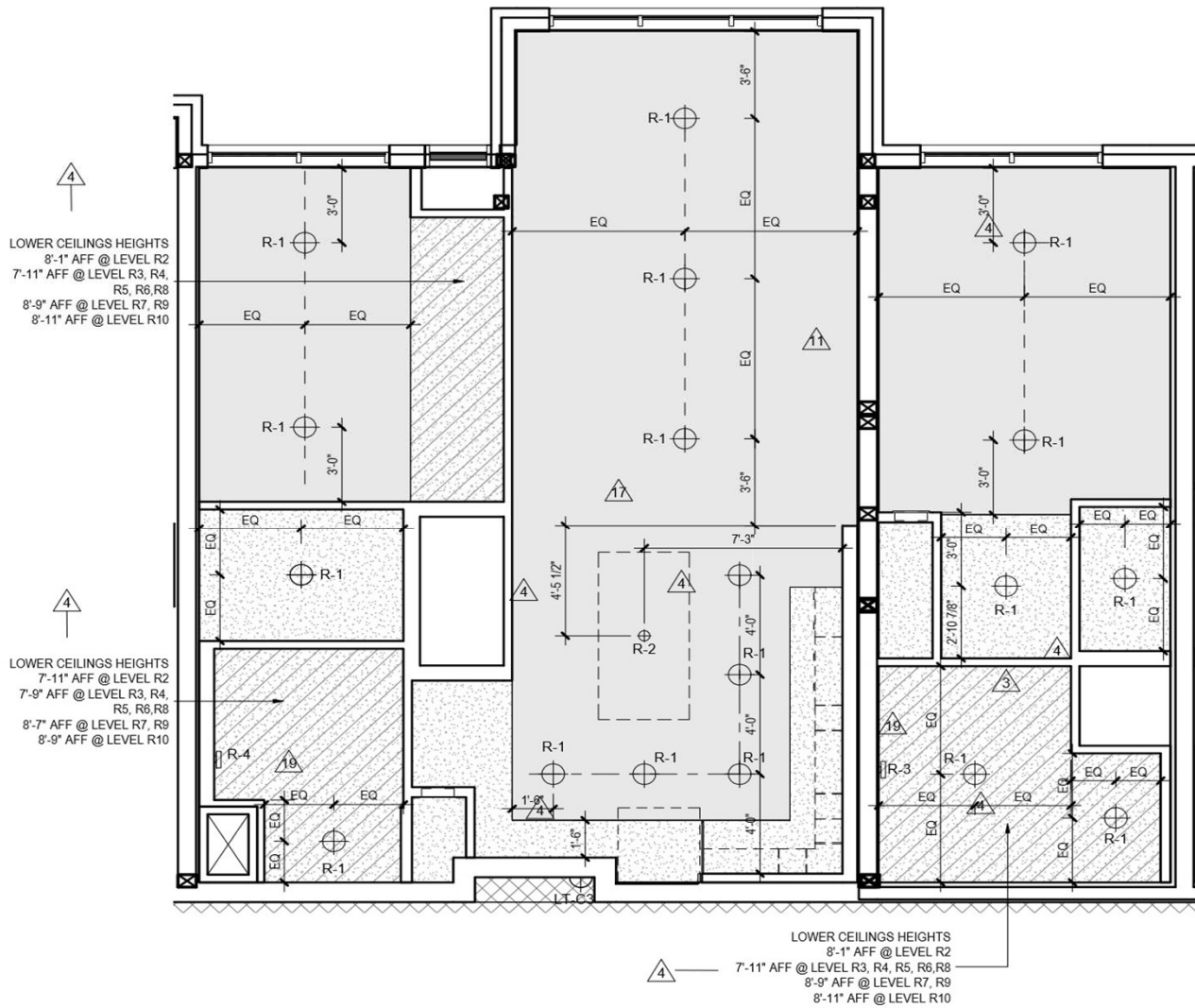

4 UNIT B3M1 RCP
 A-423 Scale: 1/4" = 1'-0"